

# 1-Phase Hybrid Inverter

## User Manual

### SH3K6-30 / SH4K6-30 / SH5K-30







# All Rights Reserved

## All Rights Reserved

No part of this document can be reproduced in any form or by any means without the prior written permission of Sungrow Power Supply Co., Ltd (hereinafter "SUNGROW").

## Trademarks

**SUNGROW** and other Sungrow trademarks used in this manual are owned by Sungrow Power Supply Co., Ltd.

All other trademarks or registered trademarks mentioned in this document are owned by their respective owners.

## Software Licenses

- It is prohibited to use data contained in firmware or software developed by SUNGROW, in part or in full, for commercial purposes by any means.
- It is prohibited to perform reverse engineering, cracking, or any other operations that compromise the original program design of the software developed by SUNGROW.

Sungrow Power Supply Co., Ltd.

Address: **No.1699 Xiyou Rd., New & High Tech Zone, Hefei, 230088, China.**

Email: **info@sungrow.cn**

Tel: +86 551 6532 7834

Website: **www.sungrowpower.com**

# About This Manual

The manual mainly describes the product information, guidelines for installation, operation and maintenance. The manual cannot include complete information about the photovoltaic (PV) system. The reader can get additional information about other devices at [www.sungrowpower.com](http://www.sungrowpower.com) or on the webpage of the respective component manufacturer.

## Validity

This manual is valid for the following inverter models:

- SH3K6-30
- SH4K6-30
- SH5K-30

They will be referred to as "inverter" hereinafter unless otherwise specified.

## Target Group

This manual is intended for:

- qualified personnel who are responsible for the installation and commissioning of the inverter; and
- inverter owners who will have the ability to interact with the inverter.



## How to Use This Manual

Read the manual and other related documents before performing any work on the inverter. Documents must be stored carefully and be available at all times.

Contents may be periodically updated or revised due to the product development. It is probably that there are changes of manual in the subsequent inverter edition. The latest manual can be acquired via visiting the website at [support.sungrowpower.com](http://support.sungrowpower.com).

## Symbols

Important instructions contained in this manual should be followed during installation, operation and maintenance of the inverter. They will be highlighted by the following symbols.

Symbol	Explanation
 <b>DANGER</b>	Indicates a hazard with a high level of risk that, if not avoided, will result in death or serious injury.
 <b>WARNING</b>	Indicates a hazard with a medium level of risk that, if not avoided, could result in death or serious injury.
 <b>CAUTION</b>	Indicates a hazard with a low level of risk that, if not avoided, could result in minor or moderate injury.

Symbol	Explanation
<b>NOTICE</b>	Indicates a situation that, if not avoided, could result in equipment or property damage.
	Indicates additional information, emphasized contents or tips that may be helpful, e.g. to help you solve problems or save time.



# Contents

---

All Rights Reserved .....	I
About This Manual .....	II
<b>1 Safety</b> .....	1
1.1 PV Panels.....	1
1.2 Utility Grid .....	1
1.3 Inverter .....	2
1.4 Battery .....	3
1.5 Skills of Qualified Personnel.....	4
<b>2 System Solution</b> .....	5
2.1 Product Introduction.....	5
2.1.1 Model Description.....	5
2.1.2 Appearance.....	5
2.1.3 Dimensions .....	6
2.1.4 LCD Panel .....	7
2.2 PV Energy Storage System (PV ESS).....	8
2.3 Retrofitting the Existing PV System .....	11
<b>3 Function Description</b> .....	13
3.1 Safety Function.....	13
3.1.1 Protection.....	13
3.1.2 Earth Fault Alarm.....	13
3.1.3 SPI and Auto Test ("IT") .....	13
3.2 Energy Conversion and Management.....	13
3.2.1 Power Derating.....	14
3.2.2 DRM ("AU"/"NZ").....	15
3.2.3 Regular Operational Voltage Range .....	16
3.2.4 Regular Operational Frequency Range.....	18
3.2.5 Reactive Power Regulation .....	20
3.2.6 Active Power Response .....	20
3.2.7 Load Control.....	21
3.3 Battery Management.....	21
3.3.1 Charge Management.....	22

3.3.2 Discharge Management .....	24
3.3.3 Maintenance Management.....	24
3.4 Communication and Configuration .....	24
<b>4 Unpacking and Storage .....</b>	<b>25</b>
4.1 Unpacking and Inspection.....	25
4.2 Identifying the Inverter .....	25
4.3 Scope of Delivery .....	26
4.4 Inverter Storage .....	28
<b>5 Mechanical Mounting .....</b>	<b>30</b>
5.1 Safety during Mounting .....	30
5.2 Location Requirements .....	30
5.2.1 Installation Environment Requirements .....	30
5.2.2 Carrier Requirements.....	31
5.2.3 Installation Angle Requirements .....	31
5.2.4 Installation Clearance Requirements .....	31
5.3 Installation Tools.....	32
5.4 Moving the Inverter .....	33
5.5 Installing the Inverter .....	33
<b>6 Electrical Connection .....</b>	<b>35</b>
6.1 Safety Instructions.....	35
6.2 Terminal Description.....	36
6.3 Electrical Connection Overview .....	38
6.4 Additional Grounding Connection .....	39
6.4.1 Additional Grounding Requirements.....	40
6.4.2 Connection Procedure .....	40
6.5 AC Cable Connection .....	41
6.5.1 AC Side Requirements.....	41
6.5.2 Assembling the AC Connector .....	41
6.5.3 Installing the AC Connector .....	43
6.6 DC Cable Connection .....	44
6.6.1 PV Input Configuration .....	44
6.6.2 DC Side Requirements.....	45
6.6.3 Assembling the PV Connectors .....	46
6.6.4 Installing the PV Connectors .....	47
6.7 Communication Connection .....	48
6.7.1 Ethernet Connection.....	49

6.7.2 WLAN Connection .....	51
6.7.3 RS485 Connection .....	51
6.8 Smart Energy Meter Connection.....	53
6.9 Battery Connection.....	56
6.9.1 Connecting the Power Cable.....	56
6.9.2 Connecting the CAN Cable .....	58
6.10 Emergency Load Connection (Backup) .....	59
6.11 DO Connection.....	61
6.12 DRM/SPI Connection .....	63
6.12.1 DRM Connection ("AU"/"NZ") .....	63
6.12.2 SPI Connection ("IT") .....	65
<b>7 Commissioning .....</b>	<b>69</b>
7.1 Inspection before Commissioning.....	69
7.2 Button Introduction.....	69
7.3 Powering on the System.....	70
7.4 LCD Initial Settings .....	71
7.4.1 Setting the Country .....	71
7.4.2 Adding the Existing Inverter.....	74
7.4.3 Setting Feed-in Power .....	75
7.4.4 Setting System Time .....	75
7.4.5 Setting Backup Function.....	75
7.4.6 Setting Reactive Power Regulation ("DE") .....	76
7.4.7 Initializing.....	76
7.5 Result Verification.....	77
7.5.1 Energy Meter Installation and Connection .....	77
7.5.2 Battery Information .....	79
7.5.3 System Time.....	80
<b>8 System Decommissioning .....</b>	<b>81</b>
8.1 Decommissioning the Inverter .....	81
8.1.1 Disconnecting the Inverter .....	81
8.1.2 Dismantling the Inverter .....	82
8.1.3 Disposal of the Inverter .....	82
8.2 Decommissioning the Battery.....	82
<b>9 Troubleshooting and Maintenance .....</b>	<b>84</b>
9.1 Troubleshooting .....	84
9.1.1 Troubleshooting of the LED Indicator .....	84

9.1.2 Troubleshooting of the Errors.....	84
9.2 Maintenance.....	97
9.2.1 Maintenance .....	98
9.2.2 Replacing the Button Battery.....	98
<b>10 Appendix I: LCD Operation .....</b>	<b>100</b>
10.1 Main Screen.....	100
10.2 LCD Menu.....	101
10.3 Starting and Stopping the Inverter .....	103
10.4 Advanced Settings .....	104
10.4.1 Inputting Password.....	104
10.4.2 Setting Backup Function.....	104
10.4.3 Adding the Existing Inverter .....	105
10.4.4 Setting Feed-in Power .....	105
10.4.5 Setting Battery Type.....	105
10.4.6 Setting Battery Usage Time.....	106
10.4.7 Setting Forced Charge.....	107
10.4.8 Setting the Protective Parameters .....	107
10.4.9 Setting Reactive Power Regulation.....	110
10.4.10 Setting Active Power Response .....	110
10.4.11 Setting Limit Power Ramp.....	110
10.4.12 Setting DO Function.....	110
10.4.13 Setting the Communication Parameters .....	113
10.4.14 DRM Switch Setting.....	113
10.4.15 Factory Reset.....	113
10.4.16 Multiple Parallel Setting.....	114
10.5 Setting System Time .....	114
10.6 Setting the Country.....	114
10.7 Viewing the Error Codes.....	116
10.7.1 Viewing Active Error.....	116
10.7.2 Viewing Error Record.....	117
10.8 Self-test (Italy).....	117
<b>11 Appendix II: Reactive Power Regulation .....</b>	<b>120</b>
11.1 "PF" mode .....	120
11.2 "Qt" mode .....	120
11.3 "Q(P)" Mode.....	120
11.3.1 For Countries "IT" and "TH" .....	121



11.3.2 For Countries except "IT" and "TH" .....	122
11.4 "Q(U)" Mode .....	123
11.4.1 For Countries "IT" and "TH" .....	123
11.4.2 For Countries except "IT" and "TH" .....	124
<b>12 Appendix III: Active Power Response .....</b>	<b>127</b>
12.1 Volt-watt Response .....	127
12.1.1 For the Country "IT" .....	127
12.1.2 For Countries "AU" and "NZ" .....	127
12.2 Frq-Watt Response .....	128
12.2.1 For the Country "IT" .....	129
12.2.2 For Countries except "IT" .....	131
12.3 Volt-watt Response (Charging) .....	132
<b>13 Appendix IV: Technical Data .....</b>	<b>135</b>
13.1 Inverter .....	135
13.2 Meter .....	138
13.3 Quality Assurance .....	138
13.4 Contact Information .....	139



# 1 Safety

The inverter has been designed and tested strictly according to international safety regulations. Read all safety instructions carefully prior to any work and observe them at all times when working on or with the inverter.

Incorrect operation or work may cause:

- injury or death to the operator or a third party;
- damage to the inverter and other properties.

All detailed work-related safety warnings and notes will be specified at critical points in this manual.



The safety instructions in this manual cannot cover all the precautions that should be followed. Perform operations considering actual onsite conditions. SUNGROW shall not be held liable for any damage caused by violation of the safety instructions in this manual.

## 1.1 PV Panels

### DANGER

PV strings will produce electrical power when exposed to sunlight and can cause a lethal voltage and an electric shock.

- Always keep in mind that the inverter is multiple power supplied. Electrical operators must wear proper personal protective equipment: helmet, insulated footwear, gloves, etc.
- Before touching the DC cables, operator must use a measuring device to ensure that the cable is voltage-free.
- The operator must follow all warnings on the PV strings and in its manual.

## 1.2 Utility Grid

Follow the regulations related to the utility grid.

**NOTICE**

All electrical connections must be in accordance with local and national standards.

Only with the permission of the local utility grid company, the inverter can be connected to the utility grid.

## 1.3 Inverter

**⚠ DANGER**

Danger to life from electric shocks due to live voltage

Do not open the enclosure when the inverter is running. Unauthorized opening will void warranty and warranty claims and in most cases terminate the operating license.

**⚠ WARNING**

Risk of inverter damage or personal injury

- Do not disconnect the PV connectors or battery connectors when the inverter is running.
- Wait at least 10 minutes for the internal capacitors to discharge after the battery is powered off. Ensure that there is no voltage or current before disconnecting any connectors.

**⚠ WARNING**

All safety instructions, warning labels, and nameplate on the inverter:

- must be clearly legible.
- should not be removed or covered.

**⚠ CAUTION**

Risk of burns due to hot components!

Do not touch any hot parts (such as the heat sink) during operation. Only the DC switch can safely be touched at any time.

**NOTICE**





Only qualified personnel can perform the country setting. Unauthorized alteration may cause a breach of the type-certificate marking.

Risk of inverter damage due to electrostatic discharge (ESD)!

By touching the electronic components, you may damage the inverter. For inverter handling, be sure to:

- avoid any unnecessary touching;
- wear a grounding wristband before touching any connectors.

**Warning Label**

Label	Description
	Disconnect the inverter from all the external power sources before maintenance!
	Do not touch live parts for 10 minutes after disconnection from the power sources.
	Burn danger due to hot surface that may exceed 60 ° C.
	Danger to life due to high voltages! Only qualified personnel can open and maintain the inverter.
	Read the user manual before maintenance!

**1.4 Battery****⚠ DANGER**

Batteries deliver electrical power, resulting in burns or a fire hazard when they are short circuited, or wrongly installed.

Lethal voltages are present at the battery terminals and cables connecting to the inverter. Severe injuries or death may occur if the cables and terminals in the inverter are touched.

**⚠ WARNING**

Provide sufficient ventilation for the battery system to prevent flames and sparks from the explosive hydrogen gas that the batteries release.

Due to the dangers of hydrogen gas and battery electrolyte:

- locate batteries in a designated area, complying with the local regulations;
- protect the enclosure against destruction;
- do not open or deform the battery;
- whenever working on the battery, wear suitable personal protective equipment (PPE) such as rubber gloves, rubber boots and goggles;
- rinse acid splashes thoroughly with clear water for a long time and consider consulting a doctor.

**NOTICE**

Improper settings or maintenance can permanently damage the battery.  
Incorrect inverter parameters will lead to the premature aging of battery.

## 1.5 Skills of Qualified Personnel

All installations must be performed by qualified personnel who should have:

- Training for installation and commissioning of electrical system, as well as dealing with hazards
- Knowledge of the manual and other related documents
- Knowledge of the local regulations and directives

## 2 System Solution

### ⚠ WARNING

- The inverter must only be operated with PV strings with class II protection in accordance with IEC 61730, application class A. It is not allowed for the positive pole or the negative pole of the PV strings or battery to be grounded. This can cause the inverter to be destroyed.
- Damages to the product due to a faulty or damaged PV installation are not covered by warranty.
- Any use other than the one described in this document is not permitted.

The single-phase hybrid inverters are applicable to both on-grid and off-grid PV systems. With the integrated Energy Management System (EMS), they can control and optimize the energy flow so as to increase the self-consumption of the system.

### 2.1 Product Introduction

#### 2.1.1 Model Description

The device model description is as follows:

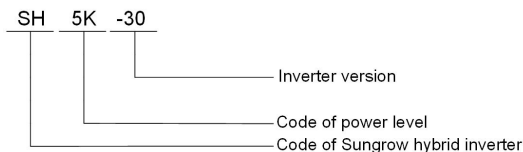

Table 2-1 Power Level Description

Model	Nominal Output Power	Nominal Grid Voltage
SH3K6-30	3680 W	
SH4K6-30	4600 W	220 Vac / 230 Vac / 240 Vac
SH5K-30	4990 W (AS4777) 5000 W (not AS4777)	(single phase)

#### 2.1.2 Appearance

The following figure shows the inverter appearance.

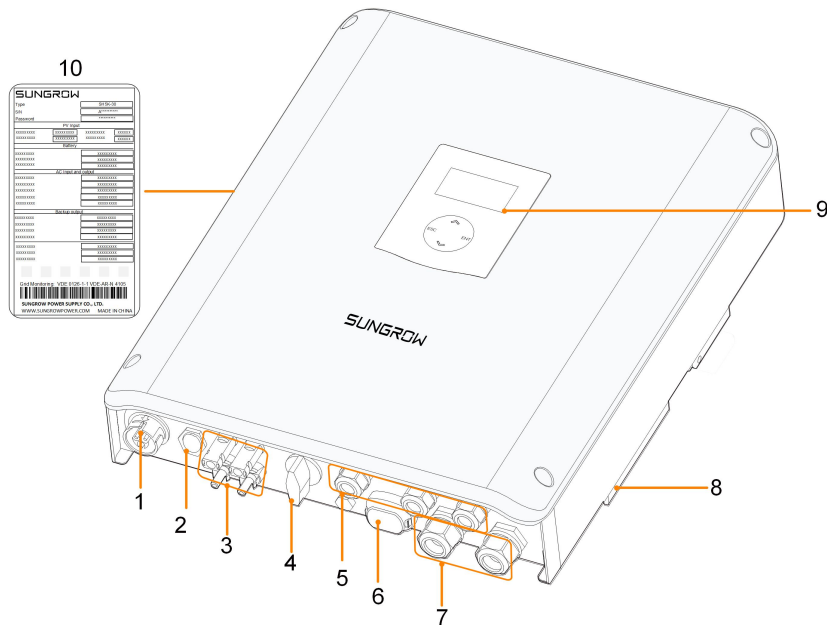

Figure 2-1 Inverter Appearance

\*The image shown here is for reference only. The actual product you receive may differ.

No.	Name	Description
1	Grid terminal	To feed power into the utility grid. The emergency loads also can be supplied from the grid.
2	Backup terminal	To connect emergency loads.
3	PV terminals	Positive and negative PV input connectors (two pairs).
4	DC switch	To safely disconnect the DC circuit.
5	Communication terminals	RS485, Ethernet, CAN, DO, DRM and SPI.
6	Wi-Fi terminal	To connect the Wi-Fi module.
7	Battery connection	BAT+ and BAT-.
8	Additional grounding terminal	For reliable grounding.
9	LCD panel	To indicate the current working state of the inverter or change inverter settings.
10	Nameplate	Clearly identify the product, including the SN, password, technical data, certifications, etc.

### 2.1.3 Dimensions

The following figure shows the dimensions of the inverter.



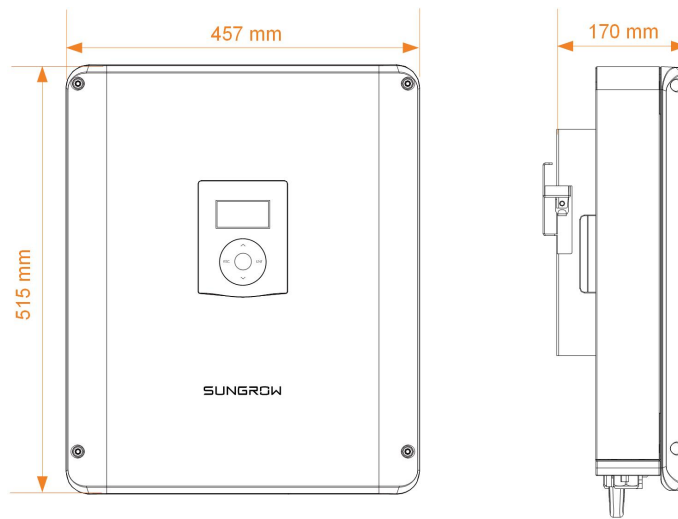

Figure 2-2 Dimensions (unit: mm)

\*The image shown here is for reference only. The actual product you receive may differ.

#### 2.1.4 LCD Panel

The LCD panel with an indicator and four buttons is on the front of the inverter.

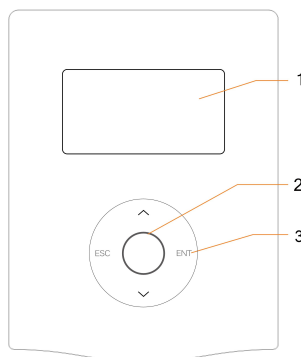

Figure 2-3 LCD Panel

No.	Name	Description
1	Screen	To display the information.
2	Indicator	To indicate the current working state of the inverter. For detailed definition, see " <a href="#">Table 7-6 State Descriptions of the LED Indicator</a> ".
3	Buttons	To view information and set parameters. For detailed functions, see " <a href="#">Table 7-1 Button Functions</a> ".

## 2.2 PV Energy Storage System (PV ESS)

By directly connecting a battery module to the inverter, the conventional PV system can be upgraded to be an Energy Storage System (ESS).

The system is capable of operating off-grid to ensure an emergency power supply for protected loads in the event of a grid interruption or blackout, which may be caused by:

- islanding;
- undervoltage or overvoltage;
- underfrequency or overfrequency.

The error codes will be displayed on the LCD screen.

### NOTICE

- For the TT utility grid, the N line voltage to ground must be 30 V or less.
- The utility grid must be a TN system for the off-grid application.
- The system is not suitable for supplying life-sustaining medical devices. It cannot guarantee backup power in all circumstances.

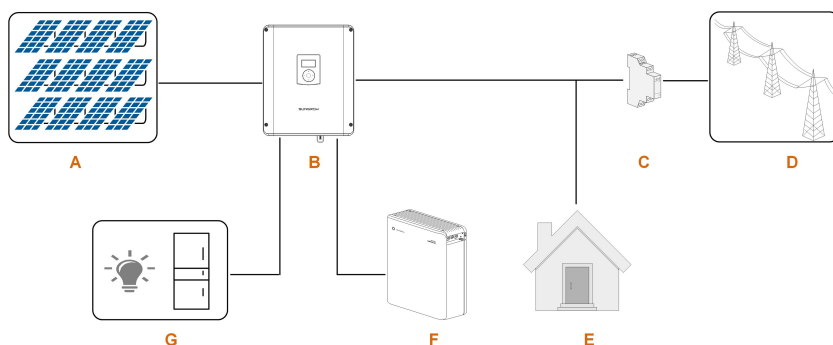

Figure 2-4 Inverter Application in PV Energy Storage System (PV ESS)

Table 2-2 System Compositions

Item	Description	Remarks
A	PV strings	Compatible with monocrystalline silicon, polycrystalline silicon, and thin-film without grounding.
B	Inverter	SH3K6-30 / SH4K6-30 / SH5K-30.
C	Smart Energy Meter (single-phase for example)	Measures the feed-in power and communicates with the inverter via the RS485 port.
D	Utility grid	Grid grounding system types: TT, TN.

Item	Description	Remarks
E	Loads	Non protected house loads, they will disconnect in case of grid failure.
F	Battery (optional)	A Li-ion battery or a lead-acid battery.
G	Protected house loads	Protected house loads directly connected to the inverter.

### Declaration For Back-Up Function

The following statement involves SUNGROW general policies about the hybrid inverters described in this manual.

- For hybrid inverters, the electrical installation typically includes connection of the inverter to both PV modules and batteries. If there is no available power from batteries or PV modules in backup mode, the backup power supply will be automatically terminated. SUNGROW shall hold no liability for any consequences arising from failing to observe this instruction.
- Normally, the Back-Up switching time is less than 20 ms. However, some external factors may cause the system to fail on Back-Up mode. Therefore, the users must be aware of conditions and follow the instructions as below:
  - Do not connect loads that are dependent on a stable energy supply for a reliable operation.
  - Do not connect the loads whose total capacity is greater than the maximum Back-Up capacity.
  - Do not connect the loads that may cause very high start-up current surges, such as air-conditioner, high-power pump, and hair drier.
  - Due to the condition of the battery itself, battery current might be limited by some factors, including but not limited to the temperature and weather.

### Declaration For Back-Up Overload Protection

The inverter will restart in case of overload protection. The time required for restarting will increase (5 min at most) if overload protection repeats. Try to reduce Back-Up load power within maximum limitation or remove the loads which may cause very high startup current surges.

### Energy Management during Daytime

The energy management system (EMS) works in self-consumption mode by default.

#### Scenario 1: PV power generation $\geq$ Load power consumption

- First, PV power will go to emergency loads first, then loads and the battery.
- Moreover, if the battery is fully charged, the excess will go to the grid. The feed-in power will not surpass the feed-in limitation value in initial settings.

#### Scenario 2: PV power generation $<$ Load power consumption

- First, battery will discharge and provide the energy missing.

- Moreover, inverter will draw power from the mains if the power from the PV and battery is less than the load power.

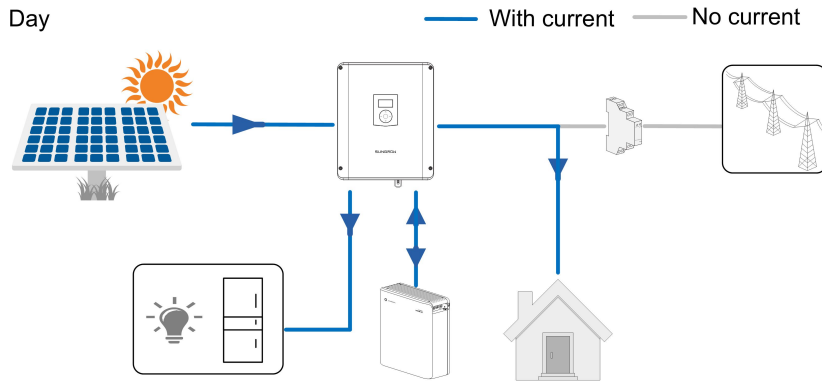

**Energy Management during Night**

The battery discharges to provide energy to loads. If the battery is empty or there is not enough power from the battery system, the grid shall supply the power, first to emergency loads, then loads.

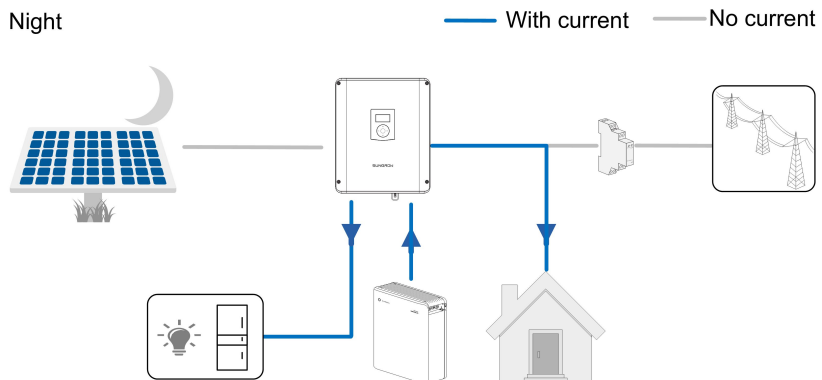

When the grid is present, the bypass function of the hybrid inverter is activated and the emergency loads will be directly connected to the grid via the bypass relay integrated in the inverter. The emergency loads are preferentially supplied with PV or battery energy, and is supplemented by the grid when the PV and battery energy are insufficient.

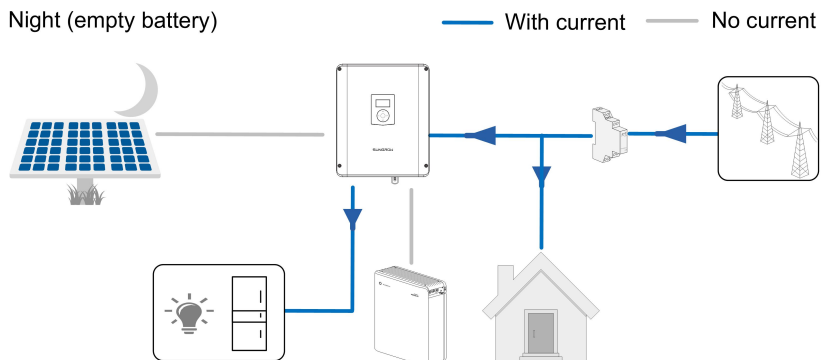

If the Smart Energy Meter is abnormal or not equipped, the inverter will run normally, however, the battery can be charged but not allowed to discharge. In this case the feed-in power setting will be ineffective, and the DO function for optimized mode will be disabled.

**Night:**

During night, with energy available, the battery will discharge to supply power for loads. Alternatively, the grid will supply power for the loads in case the discharge power of the battery is insufficient.

**Night (empty battery):**

During night, when the battery is empty, it will enter into standby mode. In this case, the grid will supply all power for loads.

## 2.3 Retrofitting the Existing PV System

The hybrid inverter is compatible with any single-phase PV grid-connected inverters. An existing PV system can be retrofitted to be a PV ESS with the addition of the hybrid inverter.

The power generation from the existing PV inverter will be firstly provided to the loads and then charge the battery. With the energy management function of the hybrid inverter, the self-consumption of the new system will be greatly improved.

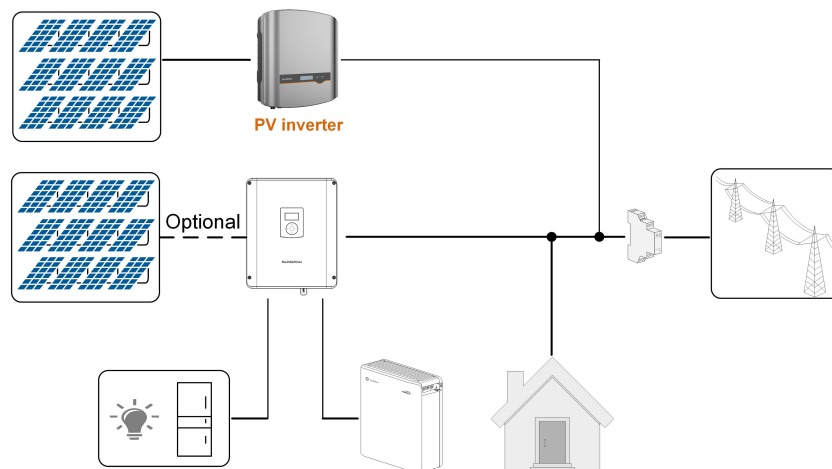
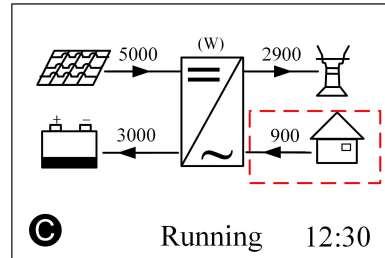

Figure 2-5 Retrofitting the Existing PV System

- In zero-export scenario, the hybrid inverter can only ensure no power exported to grid itself but does not ensure zero-export for the PV inverter. Please contact the PV inverter manufacturer for its zero-export solution.
- PV modules for hybrid inverter are optional.

The existing PV inverter provides power to the PV ESS, as the power flow shown on the main screen.



Refer to "[7.4.2 Adding the Existing Inverter](#)" to set the rated power of the existing PV inverter. The output power of the existing PV inverter should be taken into consideration for feed-in power setting.

## 3 Function Description

### 3.1 Safety Function

#### 3.1.1 Protection

Several protective functions are integrated in the inverter, including short circuit protection, grounding insulation resistance surveillance, residual current protection, anti-islanding protection, DC overvoltage/overcurrent protection, etc.

#### 3.1.2 Earth Fault Alarm

The inverter has integrated a multiple-function dry-contact (DO relay), which can be used for the external alarm for earth fault. The additional equipment required is a light indicator and/or a buzzer. The external alarm needs to be powered by the grid.

If an earth fault occurs:

- the DO dry-contact will switch on automatically to signal the external alarm;
- the buzzer inside the inverter will beep;
- the Ethernet communication port can be used for transmitting the alarm remotely.

#### 3.1.3 SPI and Auto Test ("IT")

The auto test system will check the maximum/minimum frequency and voltage provided in the interface protection system (SPI). For each frequency and voltage protection function, the tripping threshold varies linearly upward or downward with a slope of  $\leq 0.05$  Hz/s or  $\leq 0.05$  V/s respectively for the frequency and voltage protection. For details, see ["10.8 Self-test \(Italy\)"](#).

The integrated SPI is capable to receive the signals aimed at changing the frequency protection thresholds or the command of remote shutdown. For details, see ["6.12.2 SPI Connection \("IT"\)"](#).

### 3.2 Energy Conversion and Management

The inverter converts the DC power from the PV array or the battery to the AC power in conformity with the grid requirements. It also transmits the DC power from the PV panel to the battery.

With the bidirectional converter integrated inside, the inverter can charge or discharge the battery.

Two string MPP trackers are used to maximize the power from PV strings with different orientations, tilts, or module structures.

### 3.2.1 Power Derating

Power derating is a way to protect the inverter from overload or potential faults. In addition, the derating function can also be activated following the requirements of the utility grid. Situations requiring inverter power derating are:

- grid dispatching
- overtemperature (including ambient temperature and module temperature)
- grid undervoltage
- feed-in power limit setting
- power factor (when values out of the rated values)

#### Grid Dispatching Derating

Adjust the output power according to the remote scheduling instructions and the inverter operates with the power derating.

#### Overtemperature Derating

A high ambient temperature or poor ventilation will lead to a power derating of the inverter.

When the internal temperature or module temperature exceeds the upper limit, the inverter will reduce the power output until the temperature drops within the permissible range.

#### Grid Undervoltage Derating

When the grid voltage is too low, the inverter will reduce the output power to make sure that the output current is within the permissible range, as calculated by the following equation.

$$\text{When } V_{\min} < V < 230 \text{ V, } P = P_n \times (V_{\text{grid}} / 230 \text{ V})$$

The following figure shows the undervoltage derating curve.

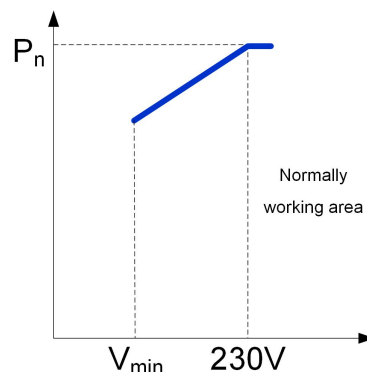

Figure 3-1 Grid Undervoltage Derating

Refer to "12 Appendix III: Active Power Response" for overvoltage curve.



### Feed-in Power Limit Derating

When the Smart Energy Meter detects that the feed-in power is greater than the limit value on the LCD, the inverter will reduce the output power within the specified range.

### Power Factor Derating

When the power factor  $PF < 1.0$ , the inverter will reduce the output power within a specified range. The following figure shows the power factor derating curve.

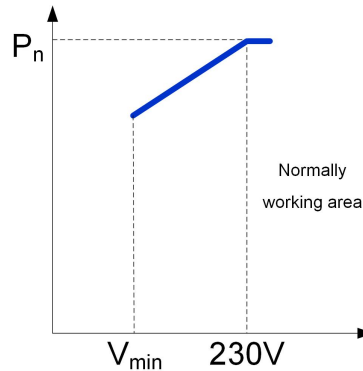

Figure 3-2 Power Factor Derating

### 3.2.2 DRM ("AU"/"NZ")

The inverter provides a terminal block for connecting to a demand response enabling device (DRED). The DRED asserts demand response modes (DRMs). The inverter detects and initiates a response to all supported demand response commands within 2s. For the connections, see "6.12.1 DRM Connection ("AU"/"NZ")".

The following table lists the DRMs supported by the inverter.

Table 3-1 Demand Response Modes (DRMs)

Mode	Explanation
DRM0	The inverter is in the state of "Turn off" .
DRM1	The import power from the grid is 0.
DRM2	The import power from the grid is no more than 50 % of the rated power.
DRM3	The import power from the grid is no more than 75 % of the rated power.
DRM4	The import power from the grid is 100 % of the rated power, but subject to the constraints from other active DRMs.
DRM5	The feed-in power to the grid is 0.
DRM6	The feed-in power to the grid is no more than 50 % of the rated power.
DRM7	The feed-in power to the grid is no more than 75 % of the rated power.
DRM8	The feed-in power to the grid is 100 % of the rated power, but subject to the constraints from other active DRMs.

The DRED may assert more than one DRM at a time. The following shows the priority order in response to multiple DRMs.

Multiple Modes	Priority Order
DRM1...DRM4	DRM1 > DRM2 > DRM3 > DRM4
DRM5...DRM8	DRM5 > DRM6 > DRM7 > DRM8

### 3.2.3 Regular Operational Voltage Range

#### European Countries (DE, BE, LUX, NL, IT)

The inverters can operate within the allowable voltage range for at least the specified observation time. The setting of the conditions depends on whether the connection is due to a normal operational start-up or an automatic reconnection after tripping of the interface protection.

When the voltage level is out of the operational levels, the inverter will disconnect from the grid in the protection time. If a disturbance lasts less than the required protection time, the inverter can reconnect to the grid if the voltage level goes back to normal levels after the disturbance.

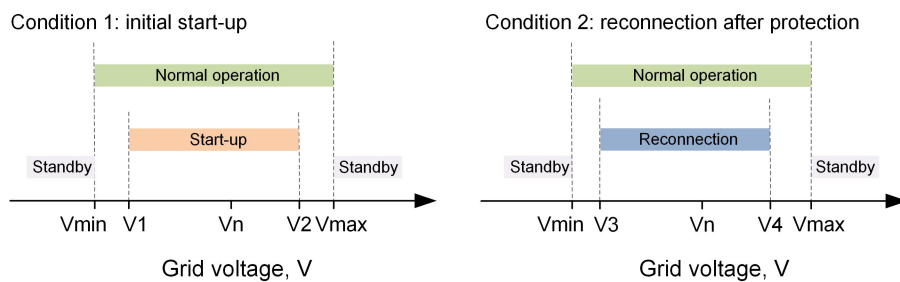

Figure 3-3 Inverter Action related to Grid Voltage ("DE" for example)

Table 3-2 Operational Voltage Parameter Description

Parameter	Description
<b>Grid-connection</b>	
V1	The lower voltage limit for initial start-up.
V2	The upper voltage limit for initial start-up.
V3	The lower voltage limit for reconnection.
V4	The upper voltage limit for reconnection.
$t_V$	Minimum observation time.
$k_V$	Connection or recovery gradient.
<b>Protection</b>	
$V_{min}$	Undervoltage protection value.

Parameter	Description
$V_{\max}$	Overvoltage protection value.
$T_{\min}$	Undervoltage protection time.
$T_{\max}$	Overvoltage protection time.

Table 3-3 Default Values of Operational Voltage Parameter

Mode	DE	BE	LUX	NL	IT
V1 (V)	195.5	195.5	195.5	195.5	197.5
V2 (V)	251.0	253.0	253.0	253.0	253.0
V3 (V)	195.5	195.5	195.5	195.5	197.5
V4 (V)	251.0	253.0	253.0	253.0	253.0
$t_v$ (s)	60	60	60	60	30 or 300 <sup>(2)</sup>
$k_v$	Not applicable or 10 % Pn/min <sup>(1)</sup>				20 % Pn/min
1- $V_{\min}$ (V)	184.0	184.0	184.0	184.0	195.5
2- $V_{\min}$ (V)	103.5	184.0	184.0	184.0	92.0
1- $V_{\max}$ (V)	287.5	264.5	264.5	253.0	264.5
2- $V_{\max}$ (V)	287.5	264.5	264.5	253.0	264.5
1- $T_{\min}$ (s)	3.1	0.2	1.35	2.0	0.4
2- $T_{\min}$ (s)	0.4	0.2	1.35	2.0	0.2
1- $T_{\max}$ (s)	0.1	0.2	0.15	2.0	0.2
2- $T_{\max}$ (s)	0.1	0.2	0.15	2.0	0.2

(1) Not applicable for initial connection and 10 % Pn/min for reconnection.

(2) 30 s for initial connection and 300 s for reconnection.

### Brazil

Nominal voltage of Brazilian grid is 220 V.

The inverters can operate within the voltage limits defined in the following table.

Table 3-4 Disconnection related to Voltage

Voltage Level at Grid-connected Point (% related to Local Nominal Voltage)	Maximum Time to Disconnect *
$V < 80\%$	0.4 s
$80\% \leq V \leq 110\%$	Normal operation
$V > 110\%$	0.2 s

\* The maximum time to disconnect refers to the interval between the abnormal voltage level and the action of inverter (disconnect from the grid).

When the voltage level is out of the operational levels shown in the table, the inverter will disconnect from the grid.

If a disturbance lasts less than the required disconnection time, the inverter can reconnect to the grid if the voltage level goes back to normal levels after the disturbance.

### 3.2.4 Regular Operational Frequency Range

#### European Countries (DE, BE, LUX, NL, IT)

The inverter can operate within the frequency allowable range for at least the specified observation time. The setting of conditions depends on whether the connection is due to a normal operational start-up or an automatic reconnection after tripping of the interface protection.

When the frequency level is out of the operational levels, the inverter will disconnect from the grid. If a disturbance lasts less than the required protection time, the inverter can reconnect to the grid if the frequency level goes back to normal levels after the disturbance.

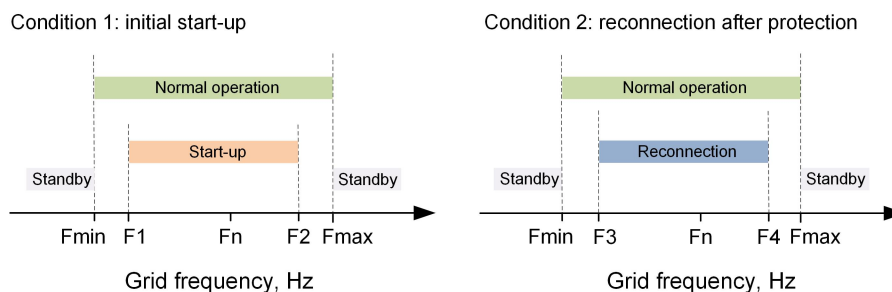

Figure 3-4 Inverter Action related to Grid Frequency ("DE" for example)

Table 3-5 Operational Frequency Parameter Description

Parameter	Description
<b>Grid-connection</b>	
F1	The lower frequency limit for initial start-up.
F2	The upper frequency limit for initial start-up.
F3	The lower frequency limit for reconnection.
F4	The upper frequency limit for reconnection.
$t_f$	Minimum observation time.
$k_f$	Connection gradient.
<b>Protection</b>	
$F_{min}$	Underfrequency protection value.

Parameter	Description
$F_{max}$	Overfrequency protection value.
$T_{min}$	Underfrequency protection time.
$T_{max}$	Overfrequency protection time.

**Table 3-6** Default Values of Operational Frequency Parameter

Mode	DE	BE	LUX	NL	IT
F1 (Hz)	47.52	47.50	47.50	48.00	49.90
F2 (Hz)	50.10	50.10	50.10	50.10	50.10
F3 (Hz)	47.52	47.50	47.50	48.00	49.90
F4 (Hz)	50.10	50.10	50.10	50.10	50.10
$t_f$ (s)	60	60	60	60	30 or 300 <sup>(2)</sup>
$k_f$	Not applicable or 10 % Pn/min <sup>(1)</sup>				20 % Pn/min
1- $F_{min}$ (Hz)	47.50	47.50	47.50	48.00	See "Table 6-3 Frequency Protection Parameters in Conditions of SPI" <sup>(3)</sup>
2- $F_{min}$ (Hz)	47.50	47.50	47.50	48.00	
1- $F_{max}$ (Hz)	50.50	50.50	52.00	51.00	
2- $F_{max}$ (Hz)	50.50	50.50	52.00	51.00	
1- $T_{min}$ (s)	0.1	0.2	0.4	2.0	
2- $T_{min}$ (s)	0.1	0.2	0.4	2.0	
1- $T_{max}$ (s)	0.1	0.2	0.4	2.0	
2- $T_{max}$ (s)	0.1	0.2	0.4	2.0	

(1) Not applicable for initial connection and 10 % Pn/min for reconnection.

(2) 30 s for initial connection and 300 s for reconnection.

(3) For Italy, the overfrequency/underfrequency protection value and time can be controlled by the SPI function or a remote command via RS485 communication. Please refer to "6.12.2 SPI Connection ("IT")" for details.

### Brazil

Nominal frequency of Brazilian grid is 60 Hz.

The inverters can operate within the frequency limits defined in the following table.

**Table 3-7** Disconnection related to Frequency

Grid Frequency Level	Maximum Time to Disconnect <sup>(1)</sup>
$f < 57.5 \text{ Hz}$	0.2 s
$57.5 \text{ Hz} \leq f \leq 62 \text{ Hz}$	Normal operation <sup>(2)</sup>
$f > 62 \text{ Hz}$	0.2 s <sup>(3)</sup>

When the frequency level is out of the operational levels shown in the table, the inverter will disconnect from the grid.

Remarks:

(1) The maximum time to disconnect refers to the interval between the abnormal frequency level and the action of inverter (disconnect from the grid).

(2) After the low frequency, the inverter will only reconnect to the grid again when the frequency returns to 59.9 Hz, respecting the reconnection waiting time of 300 seconds. When the grid frequency is more than 60.5 Hz and less than 62 Hz, the inverter will reduce the active feed-in power. Define the response curve with a start grid frequency and an end grid frequency. The inverter power output will vary in response to the increase in grid frequency. The values can be set via LCD menu. Refer to "[12.2 Frq-Watt Response](#)".

(3) After the high frequency, the inverter will only reconnect to the grid again when the grid frequency returns to 60.1 Hz, respecting the reconnection waiting time of 300 seconds. The feed-in power will grow in a rate up to 20 % per minute of  $P_{\max}$  per minute.

### 3.2.5 Reactive Power Regulation

The inverter is capable of operating in reactive power regulation modes for the purpose of providing support to the grid. The Q(U) mode can only be set via the iSolarCloud App or the iSolarCloud server. The other modes can be set via the LCD menu. For details, see "[11 Appendix II: Reactive Power Regulation](#)".

- **PF:** Fixed power factor mode. The PF mode controls the active power factor of the inverter's output according to a set-point set via the LCD. The PF ranges from 0.8 leading (+) to 0.8 lagging (-), with the default value of +1.0.
- **Qt:** Fixed reactive power mode.
- **Q(P):** Power related control mode. The displacement power factor of the inverter output varies in response to the output power of the inverter.
- **Q(U):** Voltage related control mode. The reactive power output of the inverter varies in response to the grid voltage.

### 3.2.6 Active Power Response

The inverter supports two power quality response modes, which can be set via the LCD menu. For details, see "[12 Appendix III: Active Power Response](#)".

- Volt-watt:

Define the response curve with four grid reference voltages. The inverter power output or input will vary in response to the grid voltages. Only countries Australia, New Zealand, and Italy support this response.

- Volt-watt (Charging):

When the power from the grid is required to charge the energy storage system, the import power from the grid varies in response to the grid voltages. The response curve is defined by the voltage reference values and the corresponding power consumption from the grid for charging energy storage. Only countries Australia and New Zealand support this response.

- Frq-watt:

Define the response curve with a start grid frequency and an end grid frequency. The inverter power output or input will vary in response to the increase or decrease in grid frequency.

Countries Australia, New Zealand and Italy support overfrequency/underfrequency response. Other countries only support overfrequency response.

### 3.2.7 Load Control

The inverter has integrated a multiple-function dry-contact (DO relay), which can be used for load control via a contactor. Refer to ["6.11 DO Connection"](#) for the cable connection.

User may set the control mode according to individual demand. Refer to ["10.4.12 Setting DO Function"](#) for LCD settings.

- **Timer:** Set the starting time and end time. The DO function will be enabled during the interval.
- **ON/OFF:** The DO function can be enabled or disabled.
- **Optimized:** Set the starting time, end time, and the optimized power. During the interval, when the feed-in power reaches to the optimized power, the DO function will be enabled.

## 3.3 Battery Management

The following kinds of batteries are compatible with the PV ESS. Further battery models will be made compatible in the future.

- Li-ion battery from SUNGROW, LG Chem, GCL, Pylon, BYD and TAWAKI.
- Lead-acid batteries which require manual configuration.

To maximize the battery life, the inverter will perform battery charge, discharge, and battery maintenance basing on the battery status communicated by the BMS.

### State Definition

In order to avoid over charging or deep discharging of the battery, four battery statuses according to different voltage ranges has been defined, as shown in the following table.

**Table 3-8** Battery State Definition

Type	Damaged	Empty	Normal	Full
SUNGROW (new system)	< 28 V	SOC < 5 %	5 % – 100 %	SOC = 100 %
SUNGROW (- retrofitting system or with the forced charge function enabled)	< 28 V	SOC < 10 %	10 % – 100 %	SOC = 100 %
LG	< 30 V	SOC < 5 %	5 % – 100 % (by default)	SOC = 100 %
GCL	< 30 V	SOC < 15 %	15 % – 95 % (by default)	SOC > 100 %
Pylon(US2000B), TAWAKI	< 30 V	SOC < 20 %	20 % – 100 % (by default)	SOC = 100 %
BYD	< 30 V	SOC < 10 %	10 % – 100 % (by default)	SOC = 100 %
Other lead-acid	< 30 V	Configured by the customer		

\* The SOC limits of Li-ion batteries except SUNGROW batteries can be modified via iSolarCloud App or the iSolarCloud server by qualified personnel.

### 3.3.1 Charge Management

A hybrid inverter should provide a means for temperature compensation of the battery charge voltages. This is particularly important for use with lead acid batteries in warm climates, to avoid damage to batteries by overcharging in hot weather, and related hazards due to release of hydrogen gas and cell rupture. The SH5K-30 does not include a connection terminal for a remote battery temperature sensor. If installing SH5K-30 with lead acid batteries in Australia, please check with Sungrow for advice regarding charge settings.

#### Emergency Charge Management

The emergency charge management function is to protect the battery from the damage caused by long time excessive discharge. The inverter cannot respond to discharge command during emergency charge. The following tables describe the emergency charge conditions for different types of batteries.



**Table 3-9** Emergency Charge Management for Li-ion Battery

Status	Conditions
Trigger	<p>Either of the following conditions is met:</p> <ul style="list-style-type: none"> <li>• <math>SOC \leq (\text{Min. SOC}) - 3\%</math> (valid only when the Min. SOC is <math>\geq 3\%</math>).</li> <li>• A battery under-voltage warning is triggered.</li> <li>• An emergency charge command is reported to the inverter. (only for SUNGROW and BYD batteries)</li> </ul>
Finish	<p>All the following conditions are met:</p> <ul style="list-style-type: none"> <li>• <math>SOC \geq (\text{Min. SOC}) - 1\%</math> (valid only when the Min. SOC is <math>\geq 3\%</math>).</li> <li>• The battery under-voltage warning is cleared.</li> <li>• The emergency charge command reported to the inverter is cleared. (only for SUNGROW and BYD batteries)</li> </ul>

**Table 3-10** Default SOC Conditions for Li-ion Battery Emergency Charge

Status	Trigger SOC	Finishing SOC
SUNGROW (new system)	Not applicable, triggered by BMS	
SUNGROW (retrofitting system)	$SOC \leq 2\%$	$SOC \geq 4\%$
LG	$SOC \leq 2\%$	$SOC \geq 4\%$
GCL	$SOC \leq 12\%$	$SOC \geq 14\%$
Pylon (US2000B)	$SOC \leq 17\%$	$SOC \geq 19\%$
TAWAKI	$SOC \leq 15\%$	$SOC \geq 17\%$
BYD	$SOC \leq 7\%$	$SOC \geq 9\%$

**Table 3-11** Emergency Charge Management for Lead-acid Battery

Status	Conditions
Trigger	The battery voltage is under the lower limit (42 V by default).
Finish	The battery voltage rises to the final discharge voltage.

### Normal Charge Management

When the battery voltage is within the normal range, the inverter can charge the battery if the PV power is higher than the load power and can ensure that the battery is never over-charged.

The maximum allowable charge current is limited to the smaller value among the following:

- the maximum charge current of the inverter (65 A);

- the maximum/recommended charge current from the battery manufacturer.

For this reason, the battery charge current value may not reach the nominal power.



- If the PV voltage is higher than the upper limit value of MPP voltage (560 V), the battery cannot charge.
- The hybrid inverter will start to charge the battery when the export power value exceeds a pre-defined threshold value of 70 W.

### 3.3.2 Discharge Management

Discharge management can effectively protect the battery from deep discharging.

The maximum allowable discharge current is limited to the smaller value among the following:

- the maximum discharge current of the inverter (65 A);
- the maximum/recommended discharge current from the battery manufacturer.

For this reason, the battery discharge current value may not reach the nominal power.



- If the PV voltage is higher than the upper limit value of MPP voltage (560 V), the battery cannot discharge.
- The hybrid inverter will start to discharge the battery when the import power value exceeds a pre-defined threshold value of 70 W.

### 3.3.3 Maintenance Management

To maximize the lead-acid battery life, the inverter will maintain the lead-acid battery every six months, no matter whether the PV power is sufficient or not. Generally, the maintenance management is only suitable for a lead-acid battery.

The maintenance process is as follows.

- 1 Charge the battery with a constant current of 0.165 C, in which C is the nominal capacity specified by the manufacturer and is indicated in Ah.
- 2 Charge the battery with a trickle current when the battery voltage is stabilized at the average charge voltage.
- 3 When the trickle current decreases to 3 A, end the maintenance.

## 3.4 Communication and Configuration

The inverter provides various ports for device and system monitoring, including RS485, Ethernet, WLAN, and CAN; various parameters can be configured for optimal operation. All the inverter information is accessible through the LCD screen and the iSolarCloud App.

## 4 Unpacking and Storage

### 4.1 Unpacking and Inspection

The inverter is thoroughly tested and strictly inspected before delivery. Damage may still occur during shipping. For this reason, please conduct a thorough inspection after receiving the device.

- Check the packing case for any visible damage.
- Check the scope of delivery for completeness according to the packing list.
- Check the inner contents for damage after unpacking.

Contact SUNGROW or the supplier in case of any damage or incompleteness.

Do not dispose of the original packing case. It is recommended to store the inverter in it.

### 4.2 Identifying the Inverter

The nameplate can be found on both the inverter and the packing case. It provides information on model of inverter, important specifications, marks of certification institutions, and serial number which are available and identified by SUNGROW.







SUNGROW 光伏储能逆变器	
GRID-CONNECTED HYBRID INVERTER	
型号 Type	SH5K-30
序列号 SN	A*****
密码 Password	*****
光伏输入 PV Input	
MPP电压范围 MPP Voltage Range	125V ~ 560V
最大输入电压 Max. Input Voltage	600V
最大输入电流 Max. Input Current	11A / 11A
最大短路电流 Isc PV	12A / 12A
电池 Battery	
电池类型 Battery Type	锂离子电池 Lithium / Lead-acid
电压范围 Voltage Range	32V ~ 70V
额定电压 Rated Voltage	48V
最大充/放电电流 Max. Charge / Discharge Current	65A / 65A
交流输入与输出 AC Input and Output	
额定电压 Rated Voltage	220V / 230V / 240V
额定频率 Rated Frequency	50Hz / 60Hz
最大输出功率 Max. Output Power	5000W / 5000VA
最大输入功率 Max. Input Power	8000W
最大输入/输出电流 Max. Input / Output Current	36.4A / 22.7A**
功率因数范围 Power factor range	0.8 Lead~0.8 Lag
离网输出 Backup Output	
最大输出功率 Max. Output Power	5000W / 5000VA
最大输出功率(锂电池) Max. output power (battery only)	3000W / 3000VA
额定电压 Rated Voltage	220V / 230V / 240V
额定频率 Rated Frequency	50Hz / 60Hz
最大输出电流 Max. Output Current	22.7A***
安全保护等级 Safety Class / Enclosure	Class I / IP65
工作温度范围 Ambient Temperature	-25°C ~ +60°C
过压等级 Overvoltage Category	III(MAINS)IIPV(BATTERY)
*AS 4777: 4800V / 4900VA, **AS 4777: 34.8A / 21.7A, ***AS 4777: 21.7A	
阳光电源股份有限公司 SUNGROW POWER SUPPLY CO., LTD. WWW.SUNGROWPOWER.COM 中国制造 MADE IN CHINA	

Figure 4-1 Nameplate of Inverters (SH5K-30 for example)

\* The image shown here is for reference only. The actual product received may differ.

Item	Description
1	SUNGROW logo and product type
2	Technical data of inverter
3	Instructions and marks of conformity
4	Company name, website and country of manufacture

Table 4-1 Description of Icons on the Nameplate

Icon	Description
	Regulatory compliance mark.
	TÜV mark of conformity.
	CE mark of conformity.
	Refer to the corresponding instructions.
	Do not dispose of the inverter together with household waste.
	The inverter does not have a transformer.

### 4.3 Scope of Delivery

- The single-phase Smart Energy Meter and the three-phase Smart Energy Meter are alternative in the delivery. The meter figures in this document have been created for the single-phase Smart Energy Meter unless otherwise specified.
- More detailed information on the Smart Energy Meter can be found in the respective Quick Installation Guide.

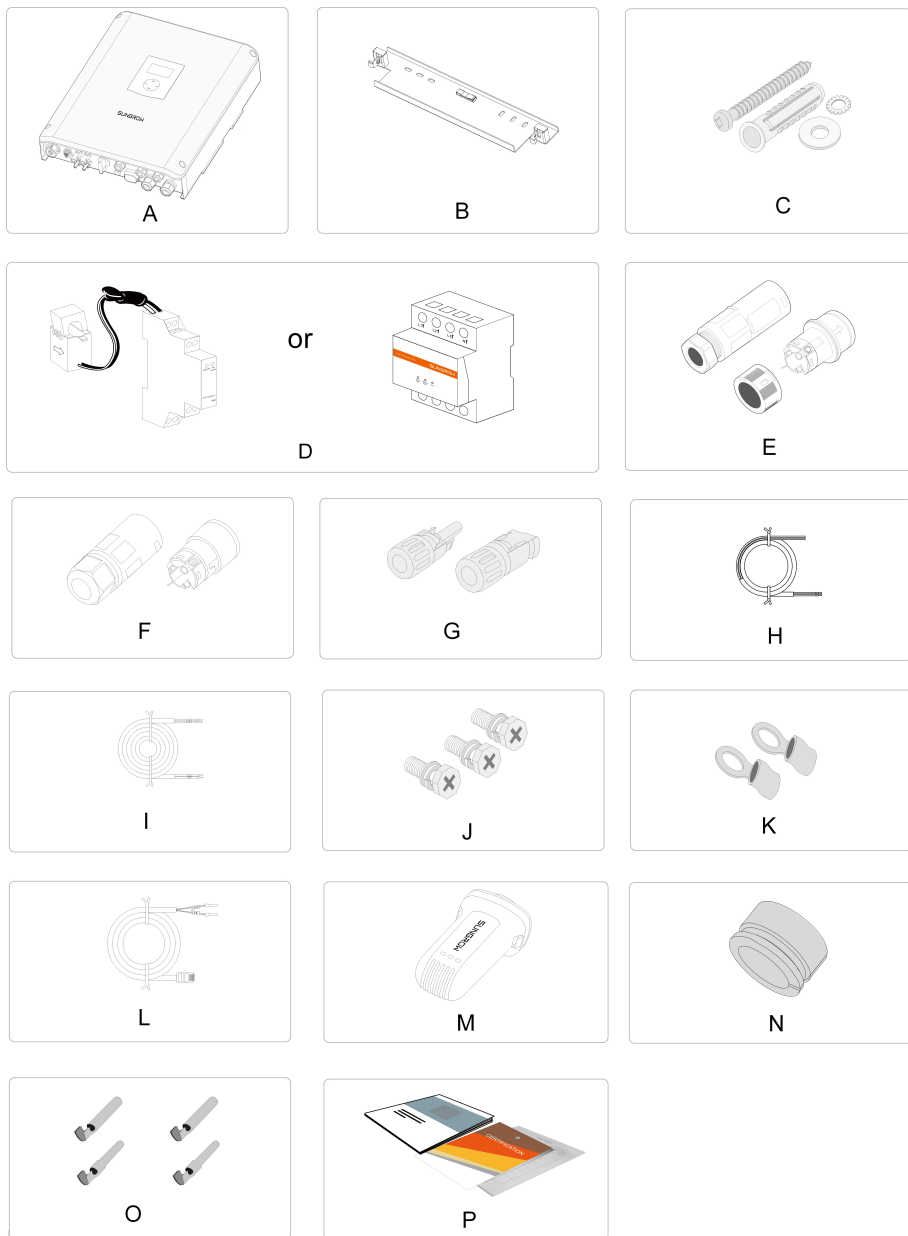

Figure 4-2 Scope of Delivery

Item	Name	Quantity	Description
A	Inverter	1 pcs	-
B	Wall-mounting bracket	1 pcs	Used to connect the inverter to the installation site.

Item	Name	Quantity	Description
C	Expansion plug sets	2 sets	Used to fasten wall-mounting bracket onto concrete wall Each set includes a self-tapping screw, a spring washer, a fender washer and an expansion tube.
D	Smart Energy meter (single-phase or three-phase)	1 pcs	Used to measure the feed-in power. If user purchases the three-phase Smart Energy Meter, it will be delivered separately.
E	AC connector set	1 set	Used to connect AC output.
F	Backup connector set	1 set	Used to connect to the emergency loads.
G	PV input connectors	2 pairs	Used to connect PV input, including positive and negative connectors.
H	Power supply cable	1 pcs	Only delivered for the single-phase Smart Energy Meter.
I	RS485 communication cable	1 pcs	Used for the communication connection of the Smart Energy Meter.
J	M5 screw sets	3 pcs	One is for external grounding and the other two are for securing the inverter.
K	OT25-6 terminals	2 pcs	Used for battery power cable connection.
L	CAN communication cable	1 pcs	Used for battery communication connection.
M	WiFi module	1 pcs	WLAN communication module.
N	Seal	1 pcs	Used for a network cable with an RJ45 plug prepared.
O	Crimp contacts	2 pairs	Two for positive PV connectors and the other two for negative PV connectors.
P	Documents	1 set	Quality certificate, packing list, test report and quick installation guide.

## 4.4 Inverter Storage

Proper storage is required if the inverter is not installed immediately.

- Store the inverter in the original packing case with the desiccant inside.
- The storage temperature must be always between  $-30^{\circ}\text{C}$  and  $+70^{\circ}\text{C}$ , and the storage relative humidity must be always between 0 and 95 %, non-condensing.
- In case of stacking storage, the number of stacking layers should never exceed the limit marked on the outer side of the packing case.
- The packing case should be upright.
- If the inverter has been stored more than half a year, the qualified personnel should thoroughly check and test it before installation.

# 5 Mechanical Mounting

## 5.1 Safety during Mounting

**⚠ DANGER**

Make sure there is no electrical connection before installation.  
In order to avoid electric shock or other injury, make sure that holes will not be drilled over any electricity or plumbing installations.

**⚠ CAUTION**

Risk of injury due to improper handling

- Always follow the instructions when moving and positioning the inverter.
- Improper operation may cause injuries or serious wounds.

In the case of poor ventilation, the system performance may compromise.

- Keep the heat sinks uncovered to ensure heat dissipation performance.

## 5.2 Location Requirements

Select an optimal mounting location for safe operation, long service life and expected performance.

- The inverter with IP 65 can be installed both indoors and outdoors.
- Install the inverter in a convenient place for electrical connection, operation, and maintenance.

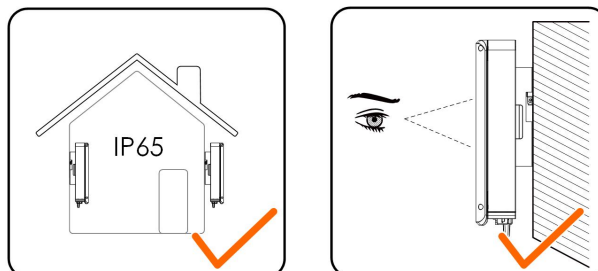

### 5.2.1 Installation Environment Requirements

- The installation environment must be free of inflammable or explosive materials.
- The location should be not accessible to children.



- The ambient temperature and relative humidity must meet the following requirements.

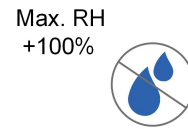
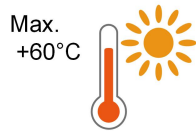

- Avoid direct exposure to sun, rain and snow.
- The inverter should be well ventilated. Ensure air circulation.
- Never install the inverter in living areas. The inverter will generate noise during operation, affecting daily life.

### 5.2.2 Carrier Requirements

The installation carrier should meet the following requirements:



Made of non-flammable materials



Max. load bearing capacity  $\geq 4$  times the inverter weight

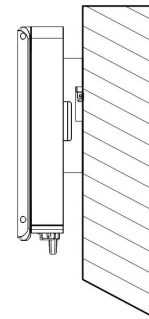

### 5.2.3 Installation Angle Requirements

Never install the inverter horizontally, or with a forward tilt/backward tilt, or even upside down.

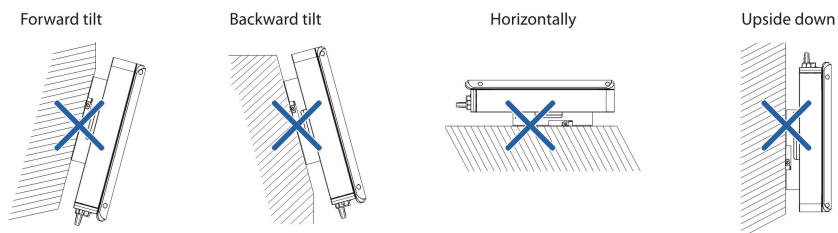

### 5.2.4 Installation Clearance Requirements

Reserve enough clearance around the inverter to ensure sufficient space for heat dissipation. Clearance requirement and multiple installation:

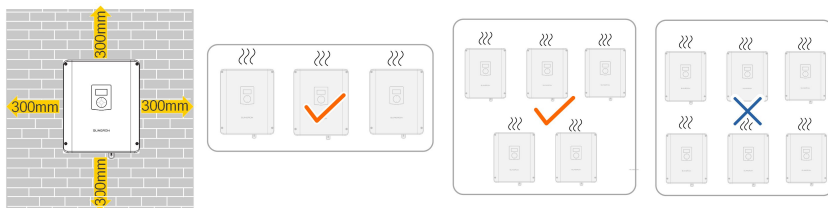

### 5.3 Installation Tools

Installation tools include but are not limited to the following recommended ones. If necessary, use other auxiliary tools on site.

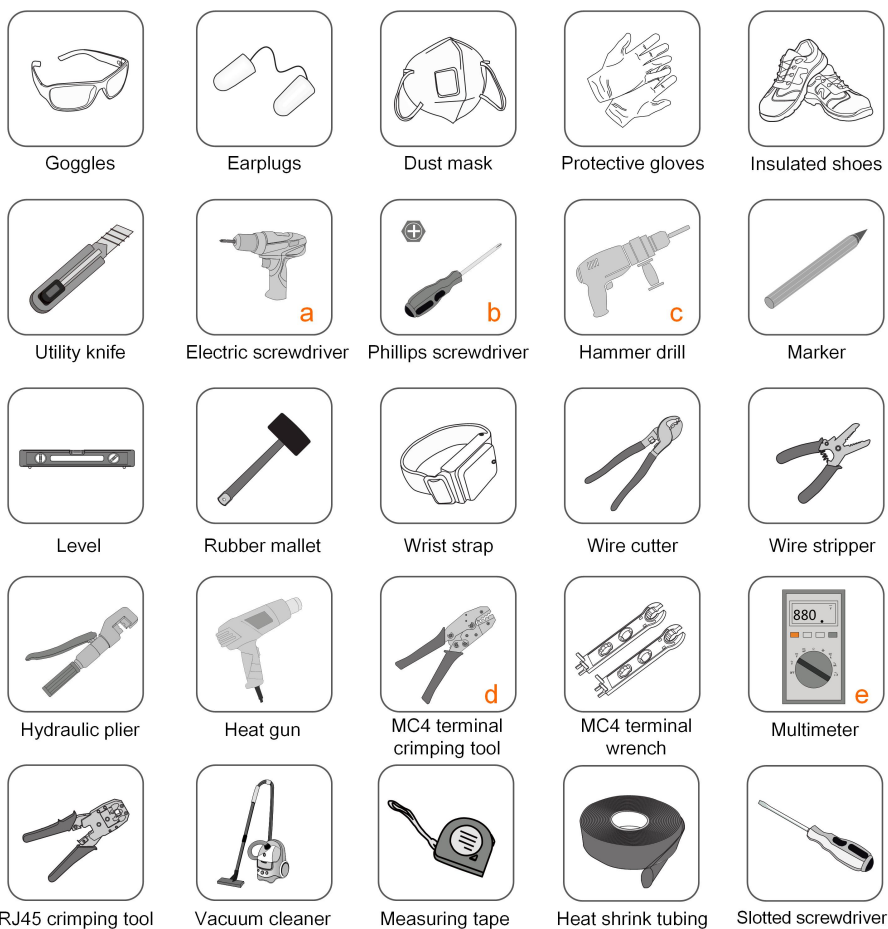

Table 5-1 Tool specification

No.	Specification
a	M5
b	M5
c	Drill bit: $\phi 10$

No.	Specification
d	Crimp range: 4 mm <sup>2</sup> – 6 mm <sup>2</sup>
e	Range: $\geq$ 600 Vdc

## 5.4 Moving the Inverter

Before installation, remove the inverter from the packing case and move it to the installation site. Follow the instructions below as you move the inverter:

- Always be aware of the weight of the inverter.
- Lift the inverter using the handles positioned on both sides of the inverter.
- Move the inverter by at least two people or by using a proper transport tool.
- Do not release the equipment unless it has been firmly secured.

## 5.5 Installing the Inverter

Inverter is installed on the wall by means of wall-mounting bracket and the expansion plug sets.

The expansion plug set shown below is recommended for the installation.

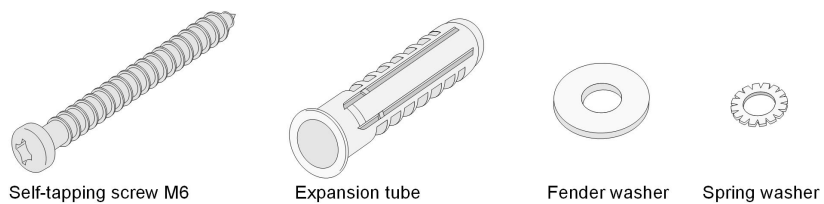

**Step 1** Install the wall-mounting bracket with a torque of 9.0 N.m.



The depth of the holes should be about 70 mm. Be sure to adhere to the screw assembly sequence: self-tapping screw, spring washer, fender washer and bracket.

The air bubble in the bracket must be between the two lines in the red circles to ensure the horizontal level.

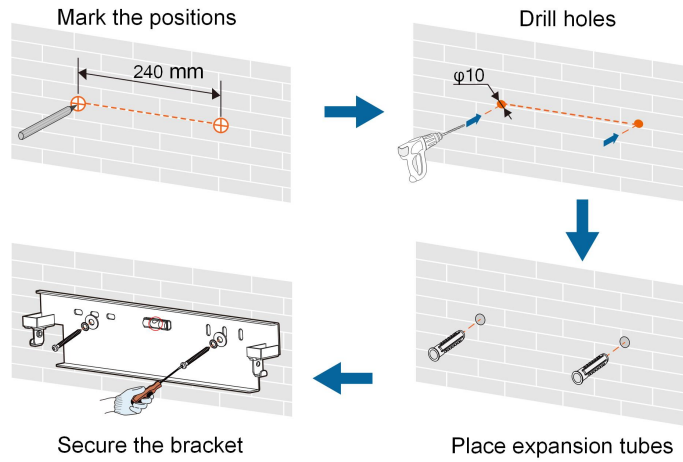

**Step 2** Mount the inverter to the bracket.

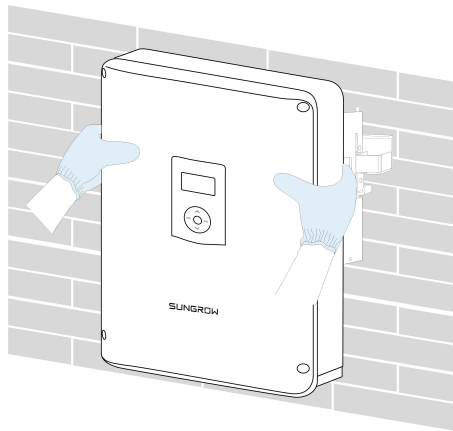

**Step 3** Secure the inverter with two M5 screws and washers. (3.0 N.m)

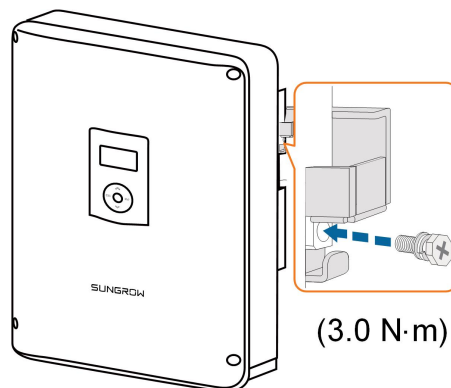

-- End

# 6 Electrical Connection

## 6.1 Safety Instructions

Prior to any electrical connections, keep in mind that the inverter has dual power supplies. It is mandatory for the qualified personnel to wear personal protective equipments (PPE) during the electrical work.

### DANGER

**Danger to life due to a high voltage inside the inverter!**

- The PV string will generate lethal high voltage when exposed to sunlight.
- Before starting electrical connections, disconnect the DC and AC circuit breakers and prevent them from inadvertent reconnection.
- Ensure that all cables are voltage free before performing cable connection.

### WARNING

- Any improper operations during cable connection can cause device damage or personal injury.
- Only qualified personnel can perform cable connection.
- All cables must be undamaged, firmly attached, properly insulated and adequately dimensioned.

### NOTICE

Comply with the safety instructions related to the PV strings and the regulations related to the utility grid.

- All electrical connections must be in accordance with local and national standards.
- Only with the permission of the local utility grid company, the inverter can be connected to the utility grid.

Before fastening the lid, be sure that:

- Seal the unused terminals with waterproof plugs.
- The rubber strip is fully filled with air.

## 6.2 Terminal Description

Terminals located at the bottom of the inverter are shown below.

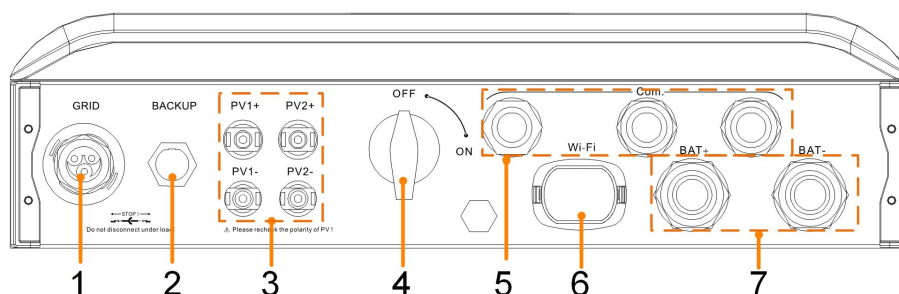
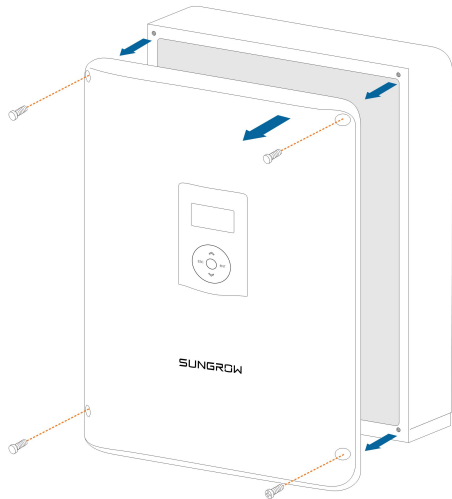

Figure 6-1 Terminals at the Bottom of the Inverter

No.	Label	Description	Decisive Voltage Classification
1	GRID	AC terminal for connection to the utility grid	DVC-C
2	BACKUP	AC terminal reserved for emergency loads *	DVC-C
3	PV1+, PV1 -, PV2+, PV2 -	Positive and negative DC input connectors	DVC-C
4	NO, OFF	DC switch	Not applicable
5	Com.	Connectors for Ethernet, RS485, CAN, DO, DRM and SPI	DVC-A
6	Wi-Fi	Connector for the WiFi module	DVC-A
7	BAT+ , BAT-	Connectors for the battery power cables	DVC-C

\* The emergency loads also can be supplied from the grid.

Unscrew four screws and remove the enclosure lid. Retain the screws for later installation with a torque of 4.2 N.m.



Connection terminals on the inner configuration circuit board are shown below.

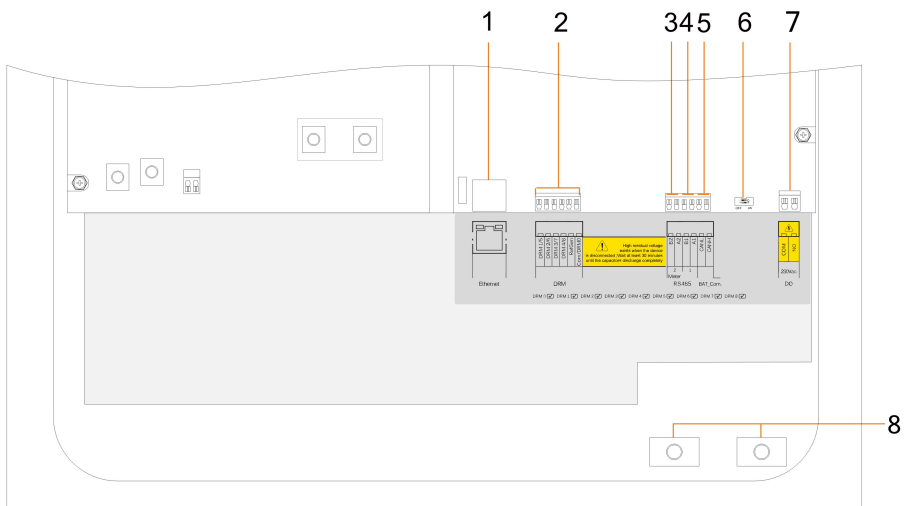

Figure 6-2 Configuration Circuit Board Inside the Inverter

No.	Label	Description	Decisive Voltage Classification
1	Ethernet	Connector for the BMS, router, and data logger	DVC-A
2	DRM	<ul style="list-style-type: none"> <li>"AU"/"NZ": Demand response enabling device (DRED)</li> <li>"IT": interface protection system (SPI)</li> </ul>	DVC-A

No.	Label	Description	Decisive Voltage Classification
3	RS485 (A2, B2)	<ul style="list-style-type: none"> <li>Connect to the Smart Energy Meter. (if installing a single inverter or if installing the master inverter in a string of parallel inverters.)</li> <li>Enable the communication between inverters in parallel. (if installing a slave inverter in a string of parallel inverters.)</li> </ul>	DVC-A
4	RS485 (A1, B1)	<ul style="list-style-type: none"> <li>Connect to an external device to receive the command to shut down the inverter remotely (Italy only)</li> <li>Enable the communication between inverters in parallel</li> </ul>	DVC-A
5	CANH, CANL	To enable the communication between the inverter and the Li-ion battery	DVC-A
6	120 Ohm	RS485	Not applicable
7	DO	<ul style="list-style-type: none"> <li>Connect to an external light indicator and/or buzzer to signal an alarm</li> <li>Connect to home load for power management</li> </ul>	DVC-A
8	BAT+, BAT-	Battery	DVC-C

### 6.3 Electrical Connection Overview

The electrical connection should be realized as follows:

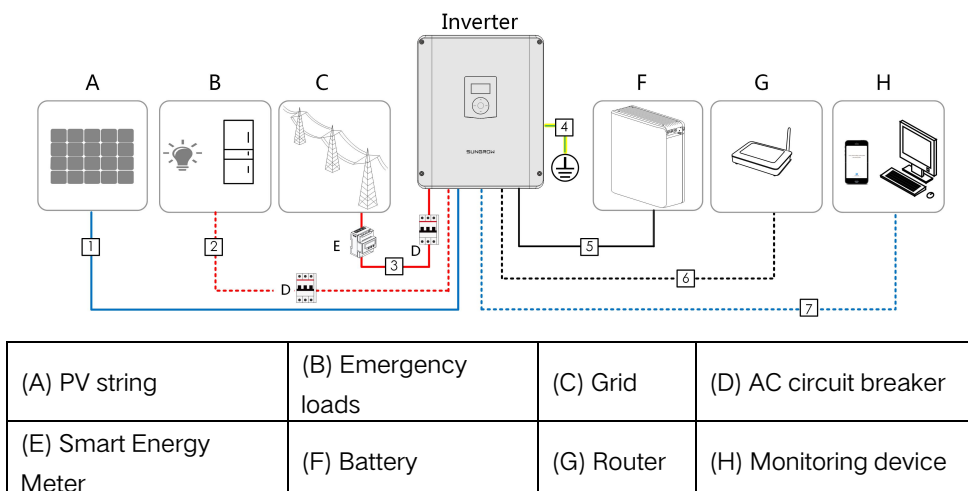



Table 6-1 Cable Requirements

N- o.	Cable	Type	Cable Diameter	Cross- section
1	DC cable	Outdoor multi-core copper wire cable complying with 600 V and 24 A standard	6 mm – 9 mm	4 mm <sup>2</sup> – 6 mm <sup>2</sup>
2	AC cable (- backup) *	Outdoor 3-core copper wire cable	10.5 mm – 15 mm	4 mm <sup>2</sup> – 6 mm <sup>2</sup>
3	AC cable (- grid) *	Outdoor 3-core copper wire cable	11 mm – 15 mm	6 mm <sup>2</sup>
4	Additional Grounding cable	Outdoor single-core copper wire cable	The same as that of the PE wire in the AC cable	
5	Battery power cable	Complying with 600 V and 24 A standard	13 mm – 16 mm	16 mm <sup>2</sup> – 25 mm <sup>2</sup>
6, 7	Ethernet cable	TIA/EIA 568B standard network cable	3 mm – 5.3 mm	/
	DRM cable	TIA/EIA 568B standard network cable	3 mm – 5.3 mm	/
/	RS485 cable	2-core wire cable	3 mm – 5.3 mm	0.5 mm <sup>2</sup>
	SPI cable (Italy)	2-core wire cable	3 mm – 5.3 mm	1.0 mm <sup>2</sup>
	DO cable	2-core wire cable	3 mm – 5.3 mm	1.0 mm <sup>2</sup>

\* All the AC cables should be equipped with correctly colored cables for distinguishing. Please refer to related standards about the wiring color.

## 6.4 Additional Grounding Connection

### WARNING

- Since the inverter is transformerless, neither the negative pole nor the positive pole of the PV string must be grounded. Otherwise, the inverter will not operate normally.
- Connect the additional grounding terminal to the protective grounding point before AC cable connection, PV cable connection, and communication cable connection.
- The ground connection of this additional grounding terminal cannot replace the connection of the PE terminal of the AC cable. Make sure thoes terminals are both grounded reliably.

### 6.4.1 Additional Grounding Requirements

All non-current carrying metal parts and device enclosures in the PV power system should be grounded, for example, brackets of PV modules and inverter enclosure.

The additional grounding terminal is equipped at the side of the inverter. Be sure to connect this additional grounding terminal to the PE bar for reliable grounding and ensure that the grounding resistance should be less than 10 Ohm.

### 6.4.2 Connection Procedure

The additional grounding cable should be of the same cross section as the PE wire in the AC cable.

Additional grounding cable and OT/DT terminal are prepared by customers.

**Step 1** Prepare the cable and OT/DT terminal.

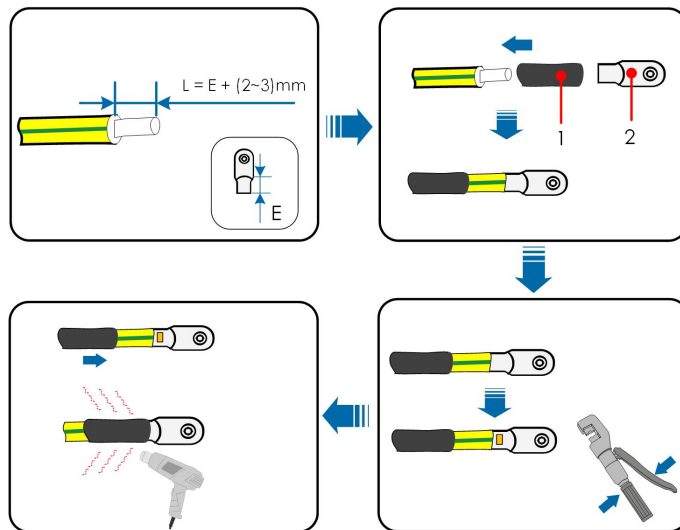

1: Heat shrink tubing

2: OT/DT terminal

**Step 2** Remove the screw on the grounding terminal and fasten the cable with a screwdriver.

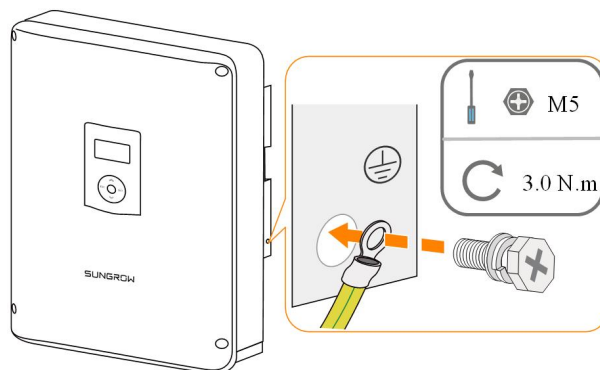

**Step 3** Apply paint to the grounding terminal to ensure corrosion resistance.

-- End

## 6.5 AC Cable Connection

### 6.5.1 AC Side Requirements

#### AC Circuit Breaker

An independent two-pole circuit breaker must be installed on the output side of the inverter to ensure safe disconnection from the grid.

Inverter Model	Recommended Specification
SH3K6-30	40 A
SH4K6-30	45 A
SH5K-30	45 A

#### NOTICE

- In the systems with multiple inverters, protect each inverter with a separate circuit breaker.
- Never connect a load between the inverter and the circuit breaker.

#### Residual Current Device

With an integrated universal current-sensitive residual current monitoring unit included, the inverter will disconnect immediately from the mains power once a fault current with a value exceeding the limit is detected.

However, if an external residual current device (RCD) is mandatory, the switch must be triggered at a residual current of 300 mA (recommended), or it can be set to other values according to local regulations. For example in Australia, the inverter can use an additional 30 mA (type A) RCD in installations.

### 6.5.2 Assembling the AC Connector

**Step 1** Lead the AC cable through the cable gland and the housing.

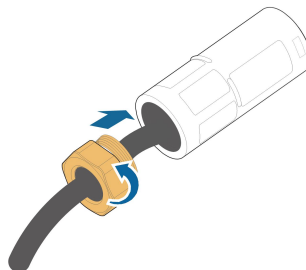

**Step 2** Put the locking ring into the housing.

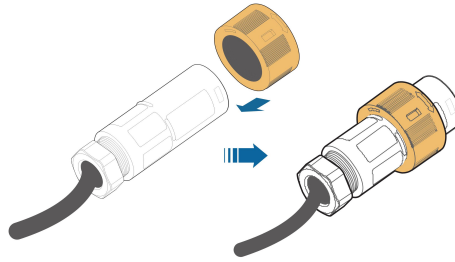

**Step 3** Remove the cable jacket by 40 mm, and strip the wire insulation by 8-15 mm.

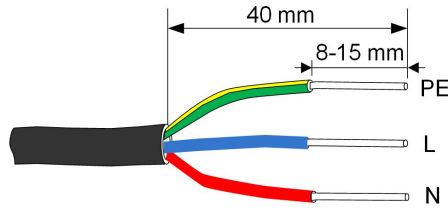

**Step 4** Fully insert the conductors to the corresponding terminal and tighten the screws with the torque 0.8 N.m. Pull cables outward to check whether they are firmly installed.



Observe the terminal layout of terminal block. Avoid connecting the phase line to terminal "PE" or "N", otherwise the inverter will not function properly and the loss of any or all the warranty rights may follow.

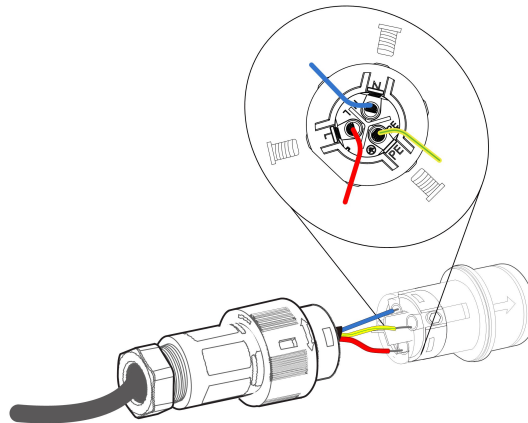

**Step 5** Assemble the housing, the terminal block and cable gland with a torque of 4 N.m. Make sure that the rib of the terminal block and the groove on the housing engage perfectly until a "Click" is heard or felt.

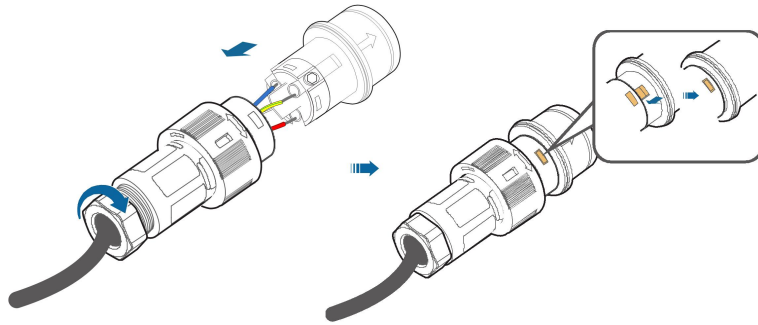

-- End

### 6.5.3 Installing the AC Connector

#### **⚠ DANGER**

High voltage may be present in the inverter!

Ensure all cables are voltage-free before electrical connection.

Do not connect the AC circuit breaker until all inverter electrical connections are completed.

**Step 1** Disconnect the AC circuit breaker and secure it against reconnection.

**Step 2** Align the AC connector and the AC terminal and mate them together by hand until a "Click" is heard or felt. (Hand-tight)

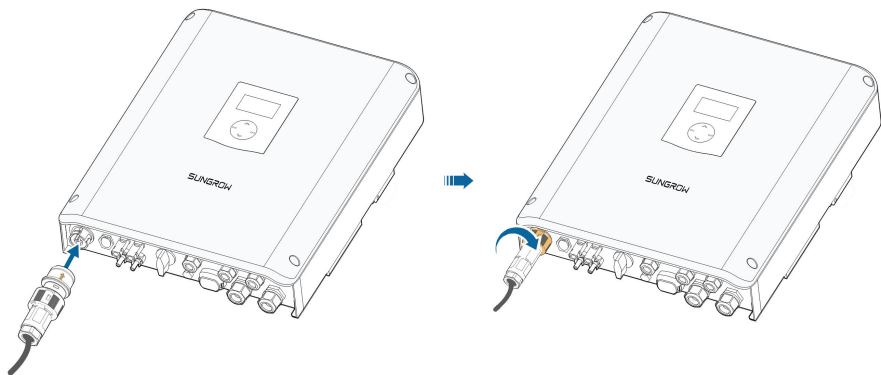

**Step 3** Connect the other ends. Connect "PE" conductor to the grounding electrode. Connect "L" and "N" conductors to the AC circuit breaker.

**Step 4** Make sure all the wires are firmly installed via the right torque tool or dragging the cables slightly.

-- End

## 6.6 DC Cable Connection

### ⚠ DANGER

Danger of electric shock!

The PV array will generate lethal high voltage once exposed to sunlight.

### ⚠ WARNING

Make sure the PV array is well insulated to ground before connecting it to the inverter.

### NOTICE

Risk of inverter damage! Observe the following requirements. Failure to do so will void guarantee and warranty claims.

- Make sure the maximum DC voltage of any string never exceeds 600 V.
- The inverter enters standby state when the input voltage ranges between 560 V and 600 V. The inverter returns to running state once the voltage returns to the MPPT operating voltage range, namely, 125 V to 560 V.
- Make sure the maximum short circuit current on the DC side is within the permissible range.

### 6.6.1 PV Input Configuration

#### Independent Mode

The two PV inputs work independently, each with its own MPPT. The two PV inputs can be different from each other in PV module types, numbers of PV panels in PV strings, tilt angles and orientation angles of PV modules. The following figure details the need for a homogenous PV string structure for maximum power.

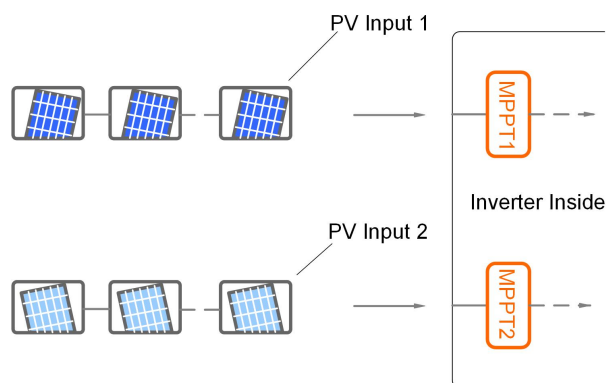

Prior to connecting the inverter to PV inputs, the specifications in the following table should be met:

Area	DC Power Limit for Each Input	Total DC Power Limit	Open-circuit Voltage Limit for Each Input	Short circuit Current Limit for Each Input
DC1/DC2	5600 W	6600 W	560 V	12 A

### Parallel Mode

Both PV strings should have the same type, the same number of PV panels, identical tilt and identical orientation. Two trackers are configured in parallel to handle power and/or current levels higher than those a single tracker can handle.

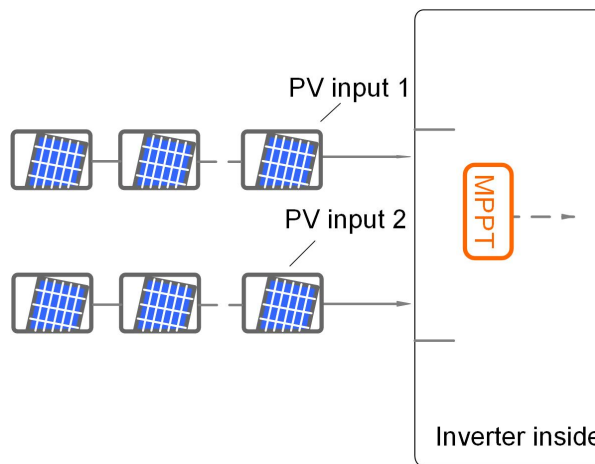

Prior to connecting the inverter to PV inputs, the specifications in the following table should be met:

Total DC Power Limit	Open-circuit Voltage Limit for Each Input	Max. current for input connector
6600 W	560 V	24 A



To avoid the power unbalance of two inputs or input load-restriction, ensure the two PV input cables are of the same type.

### 6.6.2 DC Side Requirements

SUNGROW provides corresponding PV connectors in the scope of delivery for quick connection of PV inputs.



To ensure IP65 protection, use only the supplied connector or the connector with the same ingress of protection.

### 6.6.3 Assembling the PV Connectors

#### **⚠ DANGER**

High voltage may be present in the inverter!

- Ensure all cables are voltage-free before performing electrical operations.
- Do not connect the AC circuit breaker before finishing electrical connection.

#### **NOTICE**

Use the MC4 terminals within the scope of delivery. Damage to the device due to the use of incompatible terminals shall not be covered by the warranty.

**Step 1** Strip the insulation from each DC cable by 7 mm – 8 mm.

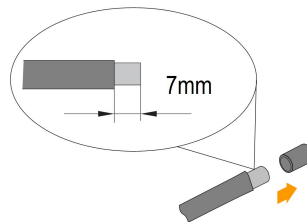

**Step 2** Assemble the cable ends with the crimping pliers.

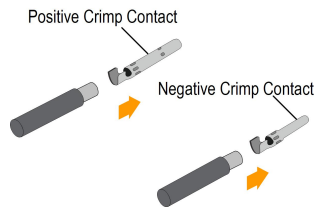

**Step 3** Lead the cable through cable gland, and insert into the insulator until it snaps into place. Gently pull the cable backward to ensure firm connection. Tighten the cable gland and the insulator (torque 2.5 N.m to 3 N.m).

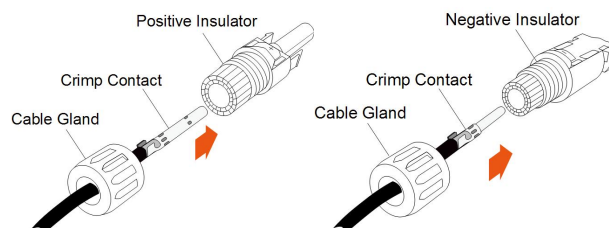

**Step 4** Check for polarity correctness.

#### **NOTICE**

The inverter will not function properly if any PV polarity is reversed.



-- End

### 6.6.4 Installing the PV Connectors

**Step 1** Rotate the DC switch to "OFF" position.

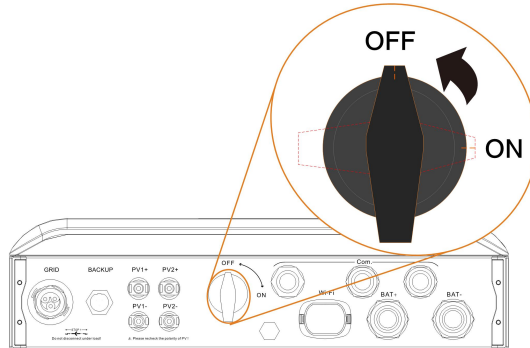

**Step 2** Check the cable connection of the PV string for polarity correctness and ensure that the open circuit voltage in any case does not exceed the inverter input limit of 600 V.

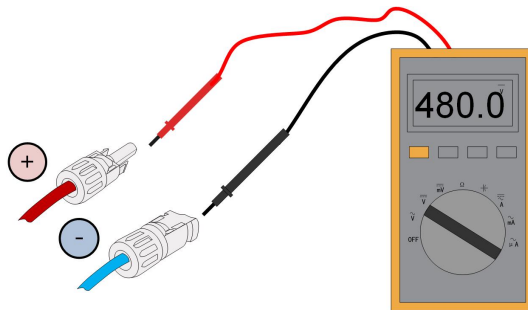

**Step 3** Connect the PV connectors to corresponding terminals until there is an audible click.

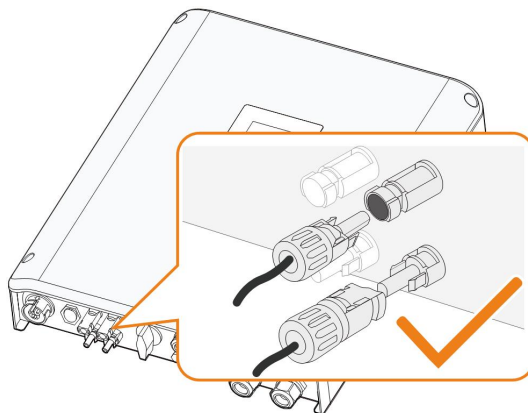

**NOTICE**

- Check the positive and negative polarity of the PV strings, and connect the PV connectors to corresponding terminals only after ensuring polarity correctness.
- Arc or contactor overtemperature may occur if the PV connectors are not firmly in place, and SUNGROW shall not be held liable for any damage caused due to this operation.

**Step 4** Seal the unused PV terminals with the terminal caps.

-- End

## 6.7 Communication Connection

There are three ports and a Wi-Fi terminal on the bottom of the inverter, as shown in the following figure.

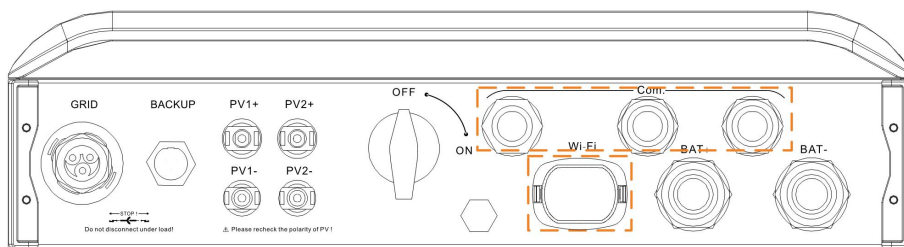

**Figure 6-3** Communication Ports and Terminal

### Ethernet Function

- Through the Modbus TCP/IP protocol, the EMS or the Control Box from the third party can fully control the on/off, derating, charging and discharging of the inverter.
- Connect the inverter to a router via the **Ethernet** port and the inverter operation information will be transferred to the cloud server.

### Wi-Fi Function

With the Wi-Fi module installed, visit the iSolarCloud App to view the inverter information.

**NOTICE**

The Ethernet and Wi-Fi communication can be used at the same time. However, they will be treated as two different systems by iSolarCloud server. It is recommended to use only one method in actual configuration.

For the communication configuration via the LCD menu, see "[10.4.13 Setting the Communication Parameters](#)".

### 6.7.1 Ethernet Connection

The following figure shows how the Ethernet connection may work with a router.

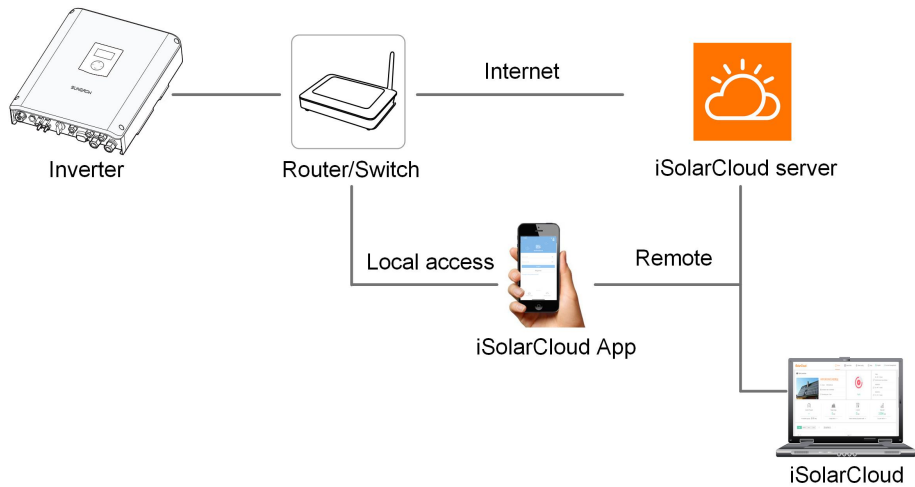
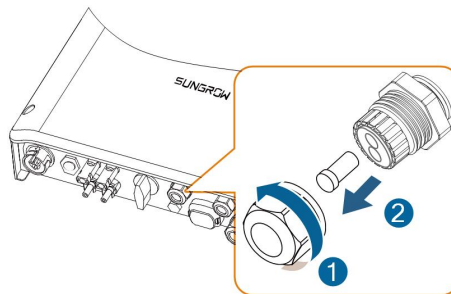

Figure 6-4 Ethernet Connection with a Router

#### Cable without RJ45 plug

- 1 Unscrew the swivel nut from any **Com.** port.



- 2 Lead the cable through the cable gland and remove the cable jacket by 8 mm – 15 mm.

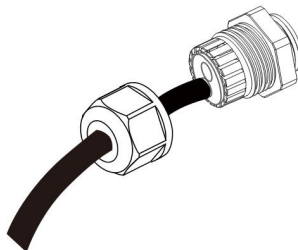

- 3 Use the Ethernet crimper to crimp the cable and connect the cable to RJ45 plug according to TIA/EIA 568B, as shown below.

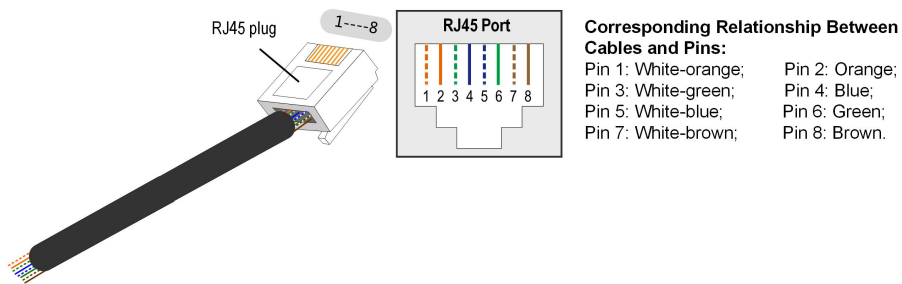

- 4 Install the RJ45 plug to the **Ethernet** port.

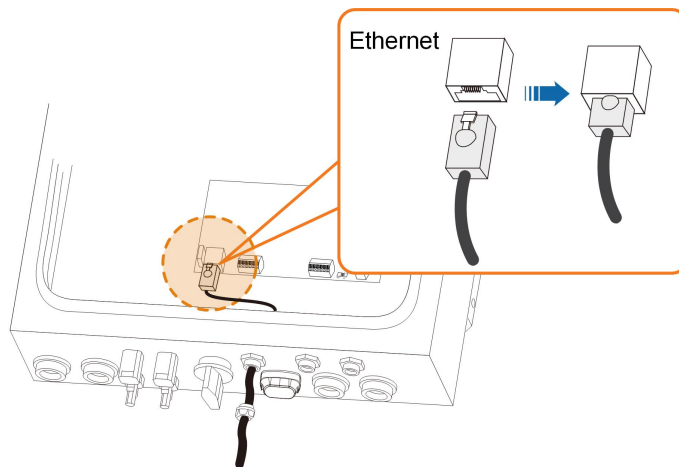

- 5 Fasten the swivel nut with a torque of 4 – 5 N.m and connect the other end to the socket of the switch or the router.

#### Cable with an RJ45 plug

- 1 Unscrew the swivel nut from any **Com.** port and remove the seal.

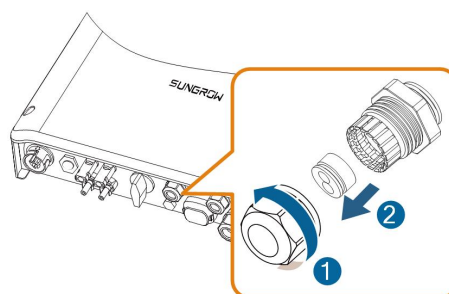

- 2 Lead the cable through the cable gland and add the support rubber.

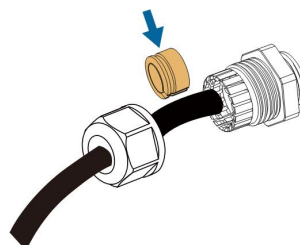

- 3 Install the RJ45 plug to the **Ethernet** port.

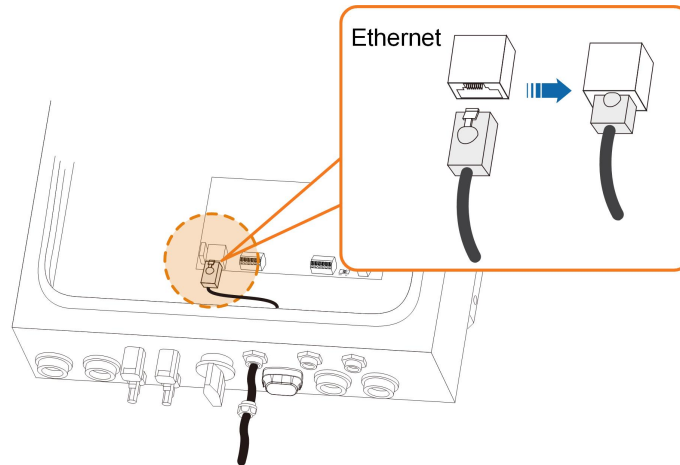

- 4 Fasten the swivel nut with a torque of 4 – 5 N.m and connect the other end to the socket of the switch or the router.

### 6.7.2 WLAN Connection

**Step 1** Unscrew the waterproof lid from the Wi-Fi terminal.

**Step 2** Install the Wi-Fi module. Slightly shake it by hand to determine whether it is installed firmly, as shown below.

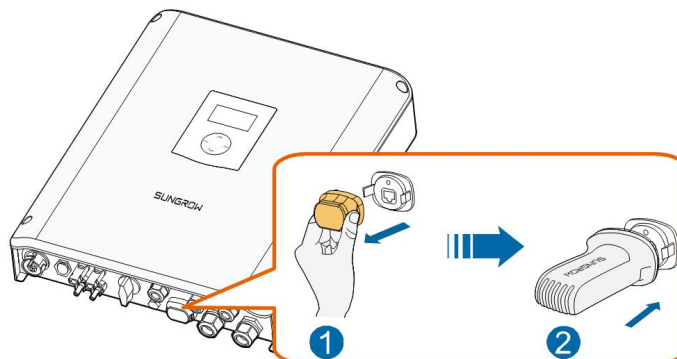

**Step 3** Refer to the **Quick User Manual** delivered with the Wi-Fi module to configure the Wi-Fi.

-- End

### 6.7.3 RS485 Connection

The RS485\_1 connection can establish the communication between an external device , as well as the communication between two inverters in parallel. In Italy, the RS485\_1 connection can be used to receive the command to shut down the inverter remotely. The RS485\_2 can be connected to the Smart Energy Meter for the feed-in power function.

**Step 1** Unscrew the swivel nut from any **Com.** port.

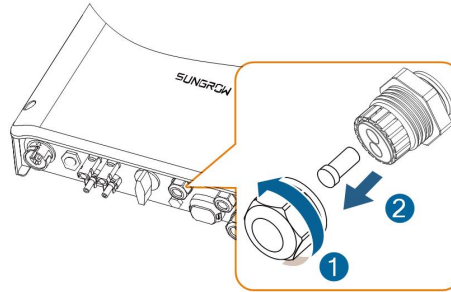

**Step 2** Lead the cable through the cable gland.

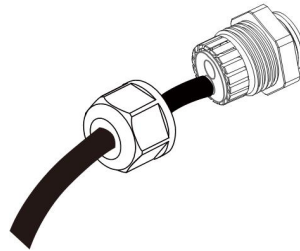

**Step 3** Remove the cable jacket and strip the wire insulation.

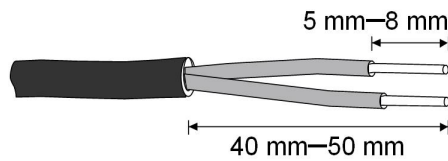

**Step 4** Plug the wires into the corresponding terminals according to the marks without tool tightening.

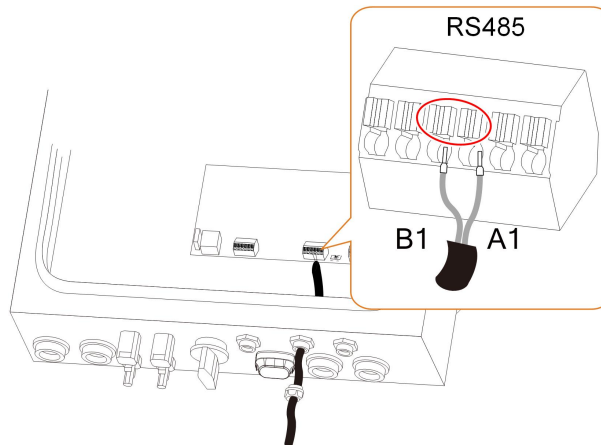

For reconnection, press the part as shown in the red circle so as to pull out the cable.

**Step 5** Fasten the swivel nut with a torque of 4 – 5 N.m and connect the other end to the external device or to the RS485\_1 terminal in slave inverter.

**Step 6** For two inverters in parallel, set the inverter directly connected to the Smart Energy Meter to **Master** and the other one to **Slave** via the LCD menu. For details, see "[10.4.16 Multiple Parallel Setting](#)".

-- End

## 6.8 Smart Energy Meter Connection

The Smart Energy Meter should be installed next to the main switch. This section mainly describes the cable connections on the inverter side. Refer to the quick guide delivered with the SUNGROW meter for the connections on the meter side.

For the single-phase meter, with the signal from the 1-phase sensor, the inverter determines the energy exchange with the utility grid on one phase. The CT clamp of 1-phase sensor can be placed before or after the main switch.

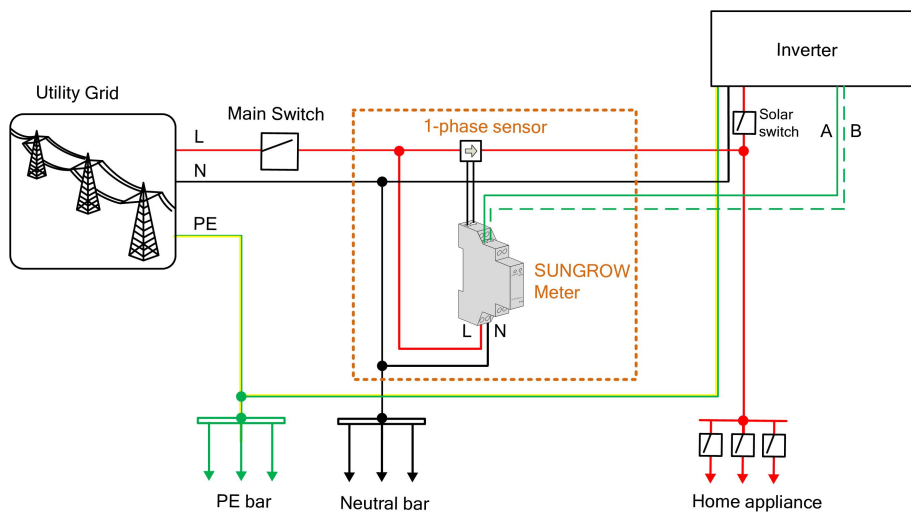

For the three-phase meter, the following figures show two connection examples for the three-phase energy meter in the PV system.

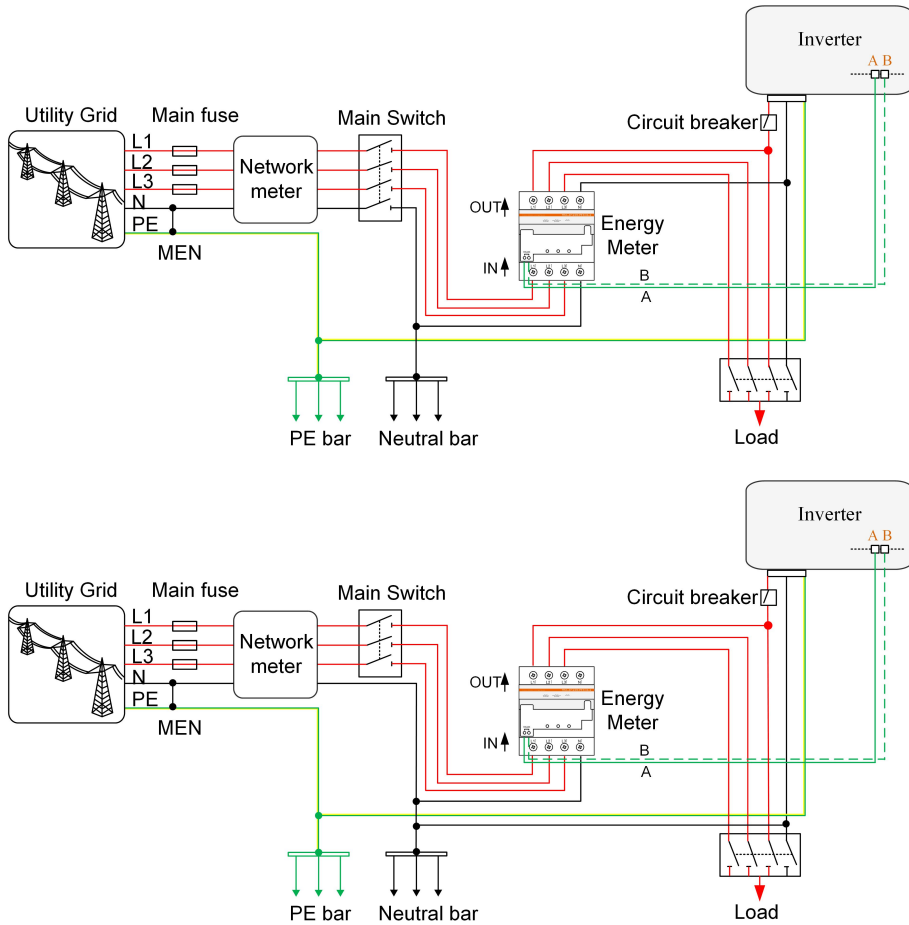

\* The MEN connection only applies to Australia and New Zealand.

**Step 1** Take out the RS485 cable (terminal marks **A2** and **B2**) from the packaging.

**Step 2** Unscrew the swivel nut from any **Com.** port.

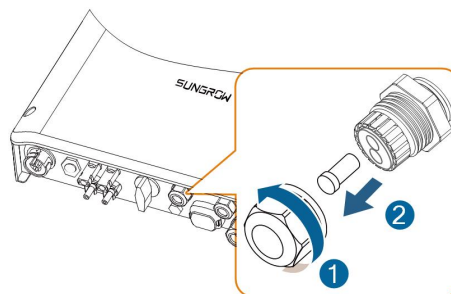

**Step 3** Lead the cable through the cable gland.



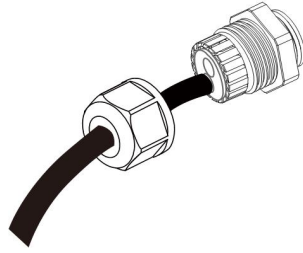

**Step 4** Plug the wires into terminals **A2** and **B2** on the inverter without tool tightening.

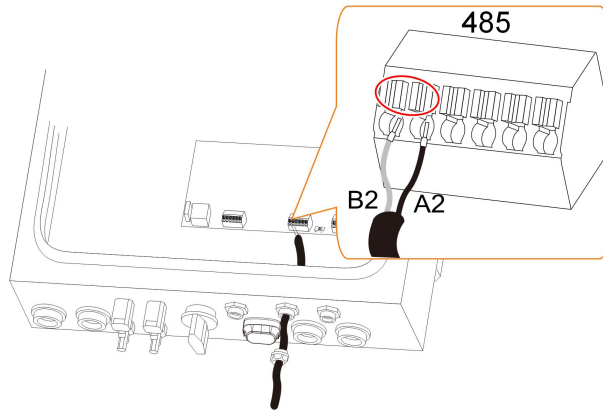

For reconnection, press the part as shown in the red circle so as to pull out the cable.

**Step 5** Fasten the swivel nut with a torque of 4 – 5 N.m and connect the other end to the Smart Energy Meter.

**Step 6** When the length of RS485 cable is longer than 100 m, push the 120 Ohm (2) switch to "ON" to ensure stable communication, as shown below.

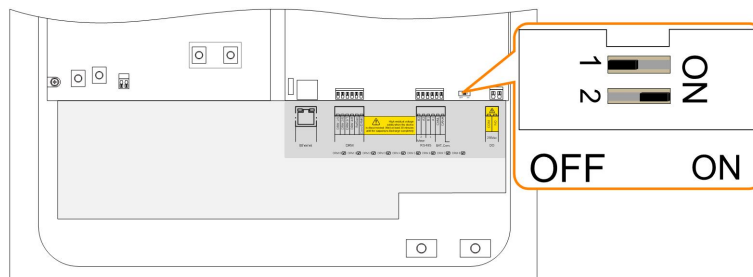

**Step 7** Set the inverter directly connected to the Smart Energy Meter to **Master** via the LCD menu. For details, see "[10.4.16 Multiple Parallel Setting](#)".

-- End

## 6.9 Battery Connection

This section mainly describes the cable connections on the inverter side. Refer to the instructions supplied by the battery manufacturer for the connections on the battery side.

### ⚠ WARNING

- Only use properly insulated tools to prevent accidental electric shock or short circuits. If insulated tools are not available, use electrical tape to cover the entire exposed metal surfaces of the available tools except their tips.
- The plug connector must be connected only by trained electricians.
- Do not disconnect under load! Battery connectors must not be disconnected while under load. They can be placed in a no load state by shutting down the inverter completely.

### 6.9.1 Connecting the Power Cable

A fuse with the specification of 150 V / 125 A (type: Bussmann BS88 125LET) is integrated to the BAT- terminal.

### NOTICE

A two-pole DC circuit breaker with overcurrent protection (voltage rating not less than 100 V and current rating not less than 100 A) should be installed between the inverter and the battery.

**Step 1** Remove the battery cable jacket.

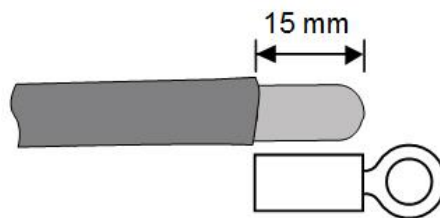

**Step 2** Crimp the OT terminal and install the heat shrinkable casing.

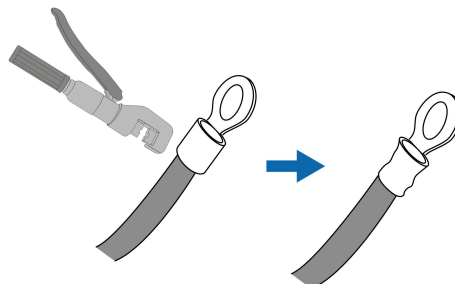

**Step 3** Unscrew the swivel nut from the **BAT+** and **BAT-** ports.

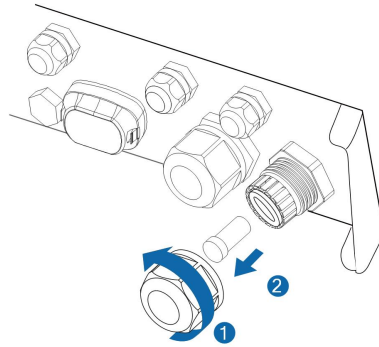

**Step 4** Lead the cable through the cable gland.

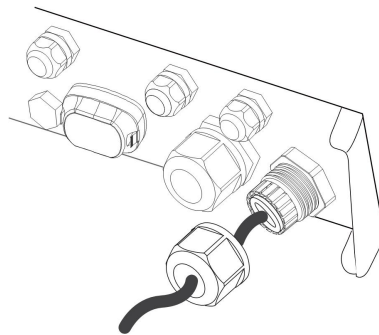

**Step 5** Loosen and remove the screw sets on the **BAT+** and **BAT-** terminal blocks. Fasten the cables to the corresponding terminals with a torque of 2.5 N.m.

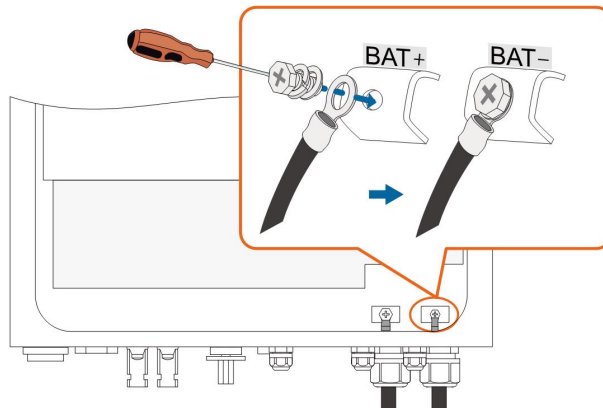

Be sure to adhere to the following screw assembly sequence: screw head, spring washer, fender washer, OT terminal.

**Step 6** Fasten the swivel nut with a torque of 5 – 6 N.m and connect the other end to the battery.

-- End

## 6.9.2 Connecting the CAN Cable

The CAN cable enables the communication between the inverter and the Li-ion battery from LG, Sungrow, GCL, Pylon (US2000B), BYD or TAWAKI.

**Step 1** Take out the CAN cable (terminal marks **CANH** and **CANL**) from the packaging.

**Step 2** Unscrew the swivel nut from any **Com.** port.

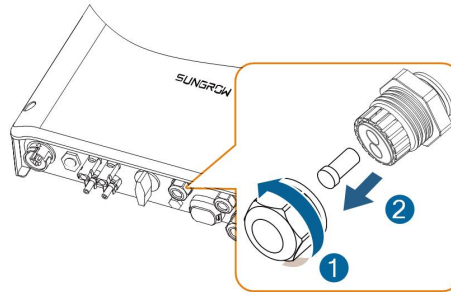

**Step 3** Lead the cable through the cable gland.

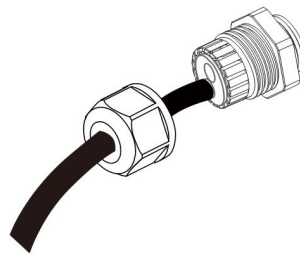

**Step 4** Plug the wires into the corresponding terminals according to the marks without tool tightening. The blue wire (pin 4) is for **CANH** and the white-blue wire (pin 5) is for **CANL**.

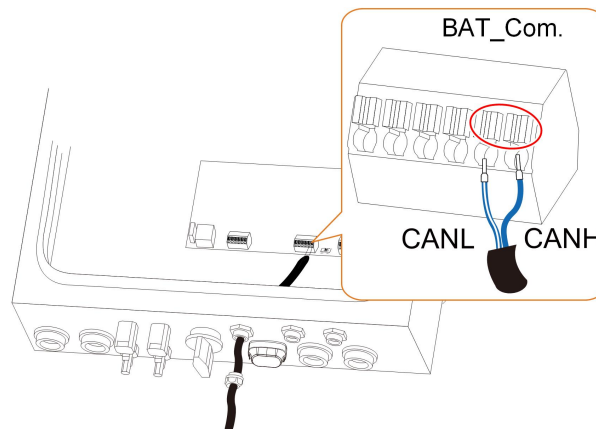

For reconnection, press the part as shown in the red circle so as to pull out the cable.

**Step 5** Fasten the swivel nut with a torque of 4 – 5 N.m and connect the other end to the battery.

-- End

## 6.10 Emergency Load Connection (Backup)

### NOTICE

Risk of inverter damage due to incorrect cable connection. Do not connect the grid power wires to **BACKUP** port.

A residual current device (RCD) of 30 mA (type B) should be installed on the output side of the **BACKUP** port of the hybrid inverter.

**Step 1** Lead the AC cable through the cable gland and the housing.

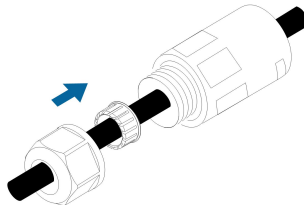

**Step 2** Remove the cable jacket by 40 mm, and strip the wire insulation by 8-15 mm.

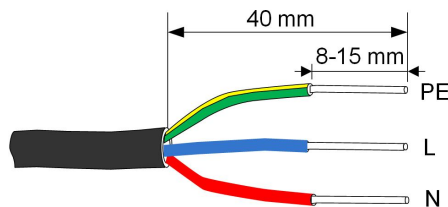

**Step 3** Fully insert the conductors to the corresponding terminal and tighten the screws with a torque of 0.8 N.m. Pull cables outward to check whether they are firmly installed.

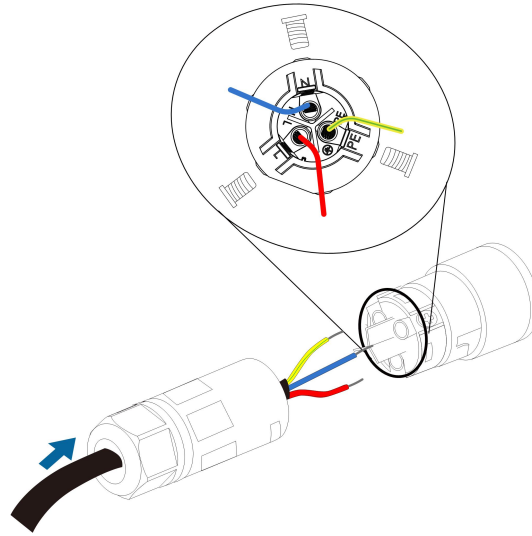

Observe the terminal layout of terminal block. Avoid connecting the phase line to terminal "PE" or "N" , otherwise the inverter will not function properly and the loss of any or all the warranty rights may follow.

**Step 4** Assemble the housing, the terminal block and cable gland with a torque of 2 – 3 N.m). Make sure that the rib of the terminal block and the groove on the housing engage perfectly until a "Click" is heard or felt.

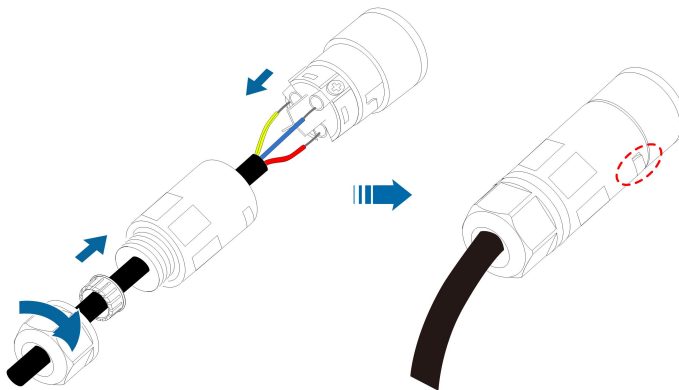

**Step 5** Align the AC connector and the AC terminal and mate them together by hand until a "Click" is heard or felt. (Hand-tight)

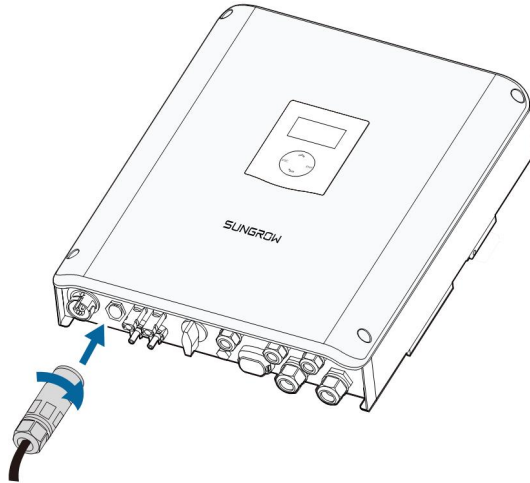

**Step 6** Connect the other ends to the emergency loads. Pull all the lines outward to check whether they are firmly installed.

-- End

## 6.11 DO Connection

The inverter has one DO relay with multiple functions as follows:

- Consumer load control. In this case the Do relay will control a contactor that will open or close in certain condition. Please choose the appropriate contactor according to the load power, e.g. the contactor types of the 3TF30 series from SIEMENS (3TF30 01-0X).
- Earth fault alarm. In this case, the additional equipment required is a light indicator and/or a buzzer.

Relay	Trigger condition	Description
Consumer load control	The load control mode has been set via the LCD menu.	The relay is activated once the conditions of the control mode are satisfied.
Earth fault alarm	The earth fault occurs.	Once the inverter receives the earth fault signal, the relay closes the contact. The relay remains triggered until the fault is removed.

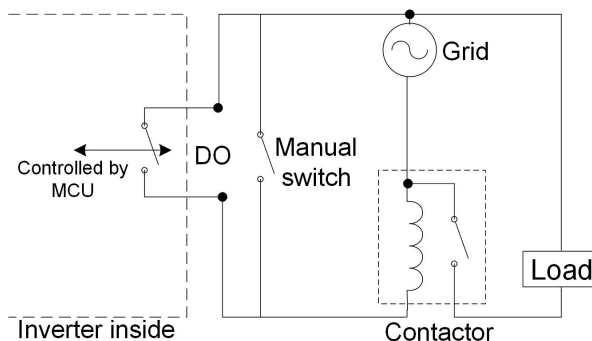
**NOTICE**

- An AC contactor must be installed between the inverter and appliances. It is prohibited to connect the load directly to the DO port.
- The current of the DO dry contact should not be larger than 3 A.
- The DO node is not controlled once the inverter is powered off. Connect the AC contactor by the manual switch, so as to control the loads.

**Step 1** Unscrew the swivel nut from any Com. port.

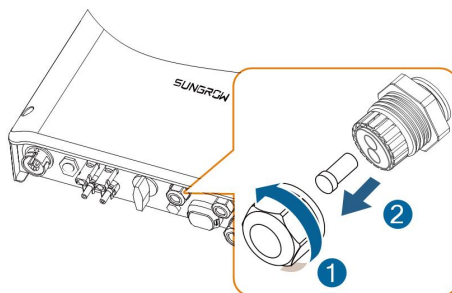

**Step 2** Lead the cable through the cable gland.

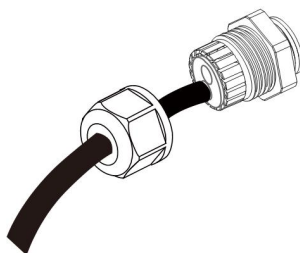

**Step 3** Remove the cable jacket and strip the wire insulation.



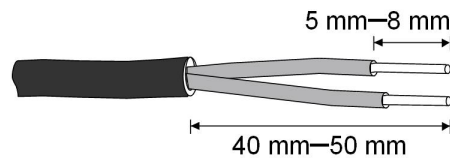

**Step 4** Plug the wires into DO terminals without tool tightening.

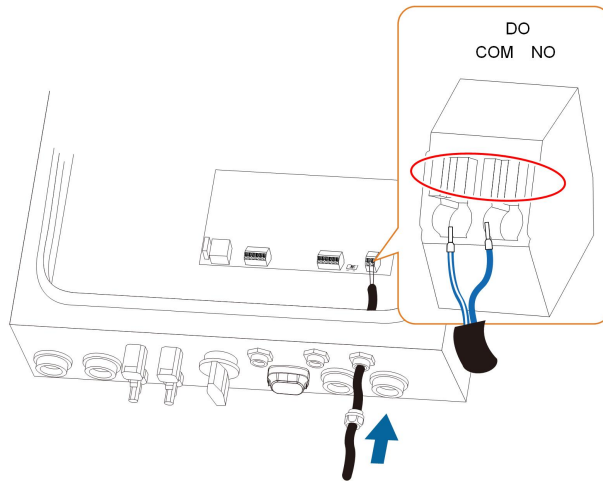

For reconnection, press the part as shown in the red circle so as to pull out the cable.

**Step 5** Fasten the swivel nut with a torque of 4 – 5 N.m and connect the other end of the cable to the original edge of the AC contactor.

-- End

## 6.12 DRM/SPI Connection

### 6.12.1 DRM Connection ("AU"/"NZ")

The inverter supports the demand response modes as specified in the standard AS/NZS 4777. The inverter has integrated a terminal block for connecting to a DRED, as shown in the following figure.

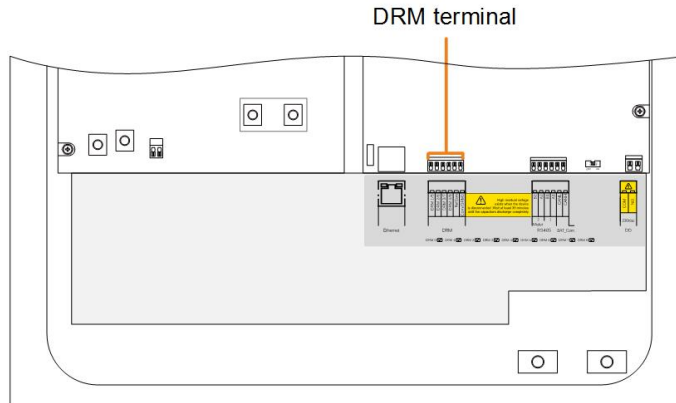

After the connection, the DRED assert DRM0 by shorting together terminals as specified in the following table. The modes from DRM0 to DRM8 are supported by the inverter and the information is marked on the label located near the DRM terminals.

Table 6-2 Method of Asserting DRMs

Mode	Asserted by Shorting Terminals
DRM0	RefGen or Com/DRM0
DRM1	1/5
DRM5	1/5 or RefGen
DRM2 / DRM6	2/6
DRM3 / DRM7	3/7
DRM4 / DRM8	4/8

**Step 1** Unscrew the swivel nut from any **Com.** port.

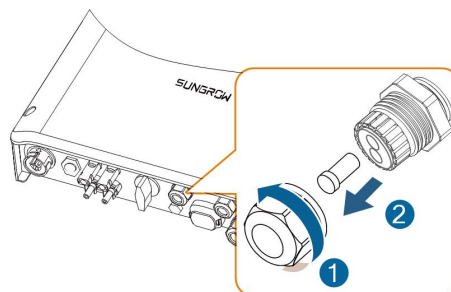

**Step 2** Lead the cable through the cable gland.

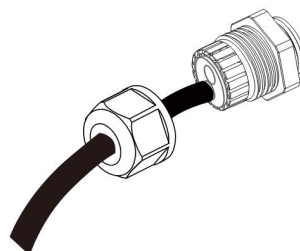

**Step 3** Remove the cable jacket and strip the wire insulation.

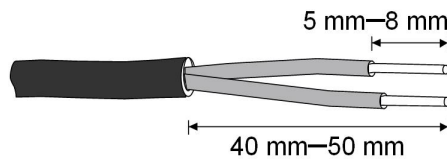

**Step 4** Plug the wires into the corresponding terminals without tool tightening, as shown below.

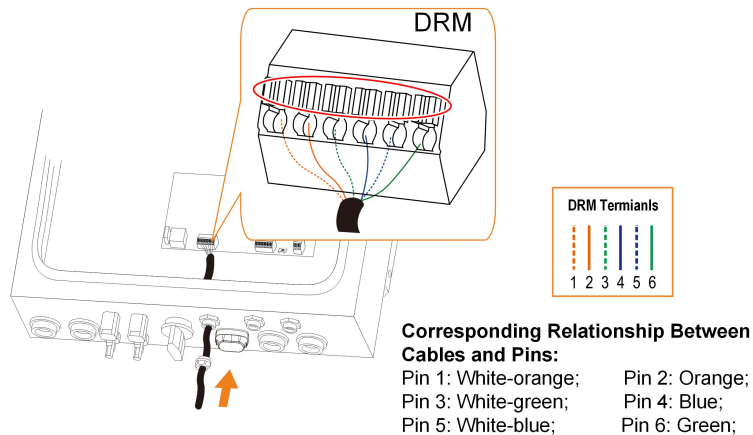

For reconnection, press the part as shown in the red circle so as to pull out the cable.

**Step 5** Fasten the swivel nut with a torque of 4 – 5 N.m and connect the other end to the DRED.

**Step 6** When the inverter is running with the demand respond commands, the DRM which is being performed by the inverter will be display on LCD screen. In "Run Info" menu, Press ▲/▼ to turn to the page showing DRM information.

Menu	1/2	DRM State	DRM1
▶ Run Info		Import Limit	100.0%
ON / OFF		Export Limit	100.0%
Settings			

-- End

### 6.12.2 SPI Connection ("IT")

The inverter has integrated the interface protection system (SPI) to provide the following functions:

- Maximum/minimum frequency protection;
- Ability to receive signals aimed at changing the frequency protection thresholds and to receive the command of remote shutdown.

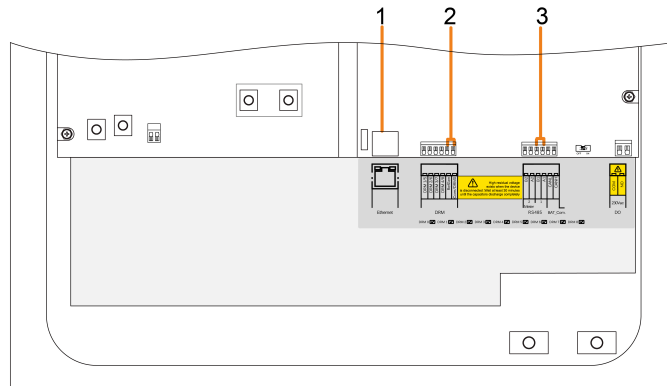

NO.	Interface	SPI Function
1	Ethernet	Receive external signal/command to change the frequency protection parameters or shutdown the inverter. See "6.7.1 Ethernet Connection" for the cable connection.
2	RefGen, Com/DRM0	Shortly connecting the two terminals will change the frequency protection parameters. See "Figure 6-5 RefGen and Com./DRM0 Connection".
3	A1, B1	Receive external command to shutdown the inverter remotely. See "Figure 6-6 RS485 Connection to External Device".

The following figure shows the cable connection to external device. Fasten the swivel nut with a torque of 4 – 5 N.m and connect the other end to the external device.

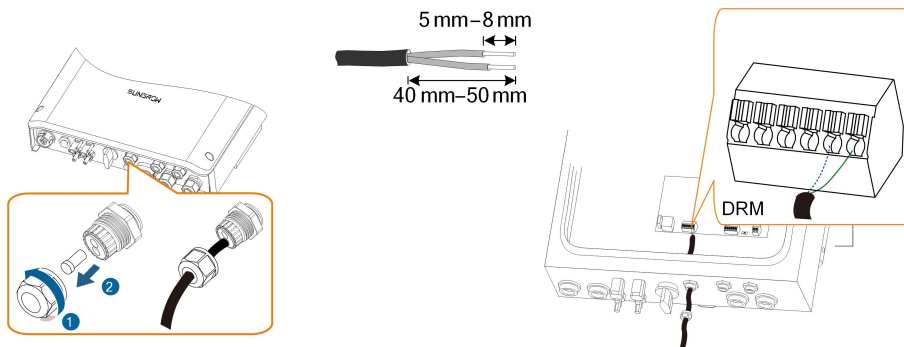

Figure 6-5 RefGen and Com./DRM0 Connection

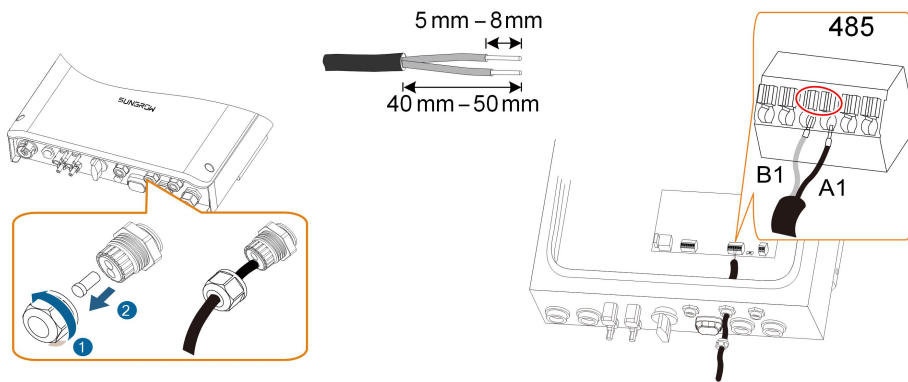

Figure 6-6 RS485 Connection to External Device



For reconnection, press the part as shown in the red circle so as to pull out the cable.

### Local Control

In this mode, the inverter is in the absence of a communication "always on" prepared by the distributor. Through the local control via *RefGen* and *Com/DRM0* terminals:

- Low (state value 0): two terminals are not connected and you can get permanent operation at permissive thresholds;
- High (state value 1): two terminals are connected and you can get permanent operation at restrictive thresholds;

### External Control

In this mode, the inverter is connected with the external device via an Ethernet cable. Through the external signal:

- Low (state value 0) in case of really operating communication
- High (state value 1) in case of external commands sent by the external device

**Note:** The local control must be set permanently in the high state (value 1).

Table 6-3 Frequency Protection Parameters in Conditions of SPI

Parameter Explanation	Local Control		External Control	
	0	1	0	1
Minimum frequency 1 (F<) (Hz)	47.50	49.80	47.50	49.80
Minimum frequency 1 (F<) tripping time (s)	0.1	0.1	4.0	0.1
Minimum frequency 2 (F<<) (Hz)	47.50	47.50	47.50	47.50
Minimum frequency 2 (F<<) tripping time (s)	0.1	0.1	4.0	4.0
Maximum frequency 1 (F>) (Hz)	51.50	50.20	51.50	50.20

Parameter Explanation	Local Control		External Control	
	0	1	0	1
Maximum frequency 1 (F>) tripping time (s)	0.1	0.1	1.0	0.1
Maximum frequency 2 (F>>) (Hz)	51.50	51.50	51.50	51.50
Maximum frequency 2 (F>>) tripping time (s)	0.1	0.1	1.0	1.0

# 7 Commissioning

## 7.1 Inspection before Commissioning

Check the following items before starting the inverter:

- All the installation sites are convenient for operation, maintenance and service.
- Check and confirm that all devices are firmly installed.
- Space for ventilation is sufficient for one inverter or multiple inverters.
- Nothing is left on the top of the inverter or battery.
- The inverter and accessories are correctly connected.
- Cables are routed in a safe place or protected against mechanical damage.
- The selection of the AC circuit breaker is in accordance with this manual and all applicable local standards.
- All unused terminals at the bottom of the inverter are properly sealed.
- Warning signs & labels are intact and legible.

## 7.2 Button Introduction

The inverter offers four buttons for operation. Please refer to the following table before any operation of the inverter.

Table 7-1 Button Functions

Button	Description
▲	For navigating up or increasing the setting value.
▼	For navigating down or decreasing the setting value.
ESC	For navigating to left, quitting the menu or canceling the settings.
ENT	For navigating to right or confirming a selection or settings.

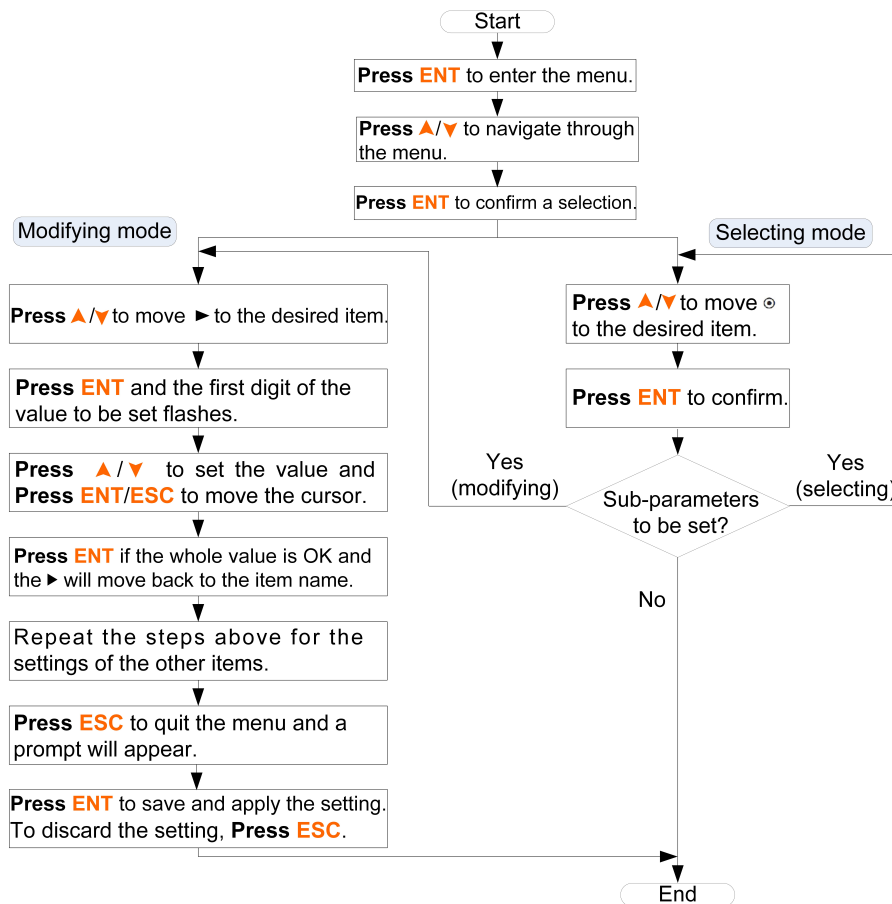

Figure 7-1 Button Operations

### 7.3 Powering on the System

If all the items mentioned in section "7.1 Inspection before Commissioning" are OK, proceed as follows to start the inverter for the first time.

**Step 1** Connect the AC circuit breaker.

**Step 2** Connect the DC circuit breaker between the inverter and the battery pack.

**Step 3 (Optional)** Power on the battery pack manually if applicable.

**Step 4** Rotate the DC switch to "ON". The DC switch may be integrated in the inverter or installed by the customer.

**Step 5** The LCD screen will be activated 5s later and enter the initial settings.

- Country Germany ("DE")



Initial Setting 1/3	Initial Setting 2/3	Initial Setting 3/3
<ul style="list-style-type: none"> <li>▶ Country</li> <li style="padding-left: 20px;">Existing Inverter</li> <li style="padding-left: 20px;">Zero-export</li> </ul>	<ul style="list-style-type: none"> <li>▶ Time</li> <li style="padding-left: 20px;">Backup Setting</li> <li style="padding-left: 20px;">Reactive Power</li> </ul>	<ul style="list-style-type: none"> <li>▶ Exit</li> </ul>

- Countries except Germany ("DE")

Initial Setting 1/2	Initial Setting 2/2
<ul style="list-style-type: none"> <li>▶ Country</li> <li style="padding-left: 20px;">Existing Inverter</li> <li style="padding-left: 20px;">Zero-export</li> </ul>	<ul style="list-style-type: none"> <li>▶ Time</li> <li style="padding-left: 20px;">Backup Setting</li> <li style="padding-left: 20px;">Exit</li> </ul>

-- End

## 7.4 LCD Initial Settings

### 7.4.1 Setting the Country

For Countries "AU" and "NZ"

Press ▲/▼ to select the grid standard and Press ENT to confirm. Set the protective parameters if you choose "Manual".

Country	Grid Standard
Country: [ AU ]	<input type="radio"/> AG <input type="radio"/> EE <input type="radio"/> EG <input type="radio"/> PN <input type="radio"/> PC <input type="radio"/> WP <input type="radio"/> Manual <input checked="" type="radio"/> Default

Table 7-2 Grid Standard Description

Grid Standard	Company
AG	AusGrid,NSW
EE	Ergon Energy,QLD
EG	Energex,QLD
PN	SA Power Networks,SA
PC	Powercor,VIC
WP	Western Power,WA
Default	Company not mentioned above

\* The values listed in the following table are for your reference only. Please follow local grid requirements.

Table 7-3 Parameters of Grid Standards in Australia

Parameter	Default	AG	EE	EG	PN	PC	WP
<b>Overvoltage</b>							
1-V <sub>max</sub> (V)	260.0	260.0	260.0	260.0	260.0	260.0	260.0
1-Time (s)	2.0	1.80	1.80	1.80	1.80	1.80	1.80
1-V <sub>max</sub> (V)	265.0	265.0	265.0	265.0	265.0	265.0	265.0
2-Time (s)	0.20	0.20	0.20	0.20	0.20	0.20	0.20
<b>Undervoltage</b>							
1-V <sub>min</sub> (V)	180.0	200.0	180.0	180.0	180.0	180.0	180.0
1-Time (s)	2.0	1.80	1.80	1.80	1.80	1.80	1.80
1-V <sub>min</sub> (V)	180.0	200.0	180.0	180.0	180.0	180.0	180.0
2-Time (s)	2.0	1.80	1.80	1.80	1.80	1.80	1.80
<b>Overfrequency</b>							
1-F <sub>max</sub> (V)	52.00	52.00	52.00	52.00	52.00	52.00	51.50
1-Time (s)	0.20	0.20	0.20	0.20	0.20	0.20	0.20
1-F <sub>max</sub> (V)	52.00	52.00	52.00	52.00	52.00	52.00	51.50
2-Time (s)	0.20	0.20	0.20	0.20	0.20	0.20	0.20
<b>Underfrequency</b>							
1-F <sub>min</sub> (V)	47.00	48.00	47.00	47.00	47.00	47.00	47.00
1-Time (s)	1.50	1.50	1.50	1.50	1.50	1.50	1.50
1-F <sub>min</sub> (V)	47.00	48.00	47.00	47.00	47.00	47.00	47.00
2-Time (s)	1.50	1.50	1.50	1.50	1.50	1.50	1.50
10-min voltage	255.0	255.0	255.0	257.0	255.0	255.0	255.0

\* In New Zealand, the default value for underfrequency protection is 45.00 Hz, the others are the same as in Australia. Refer to "Table 10-9 Description of Multi. Stage Protective Parameters" for the parameter explanations.

The single stage parameters are as follows.

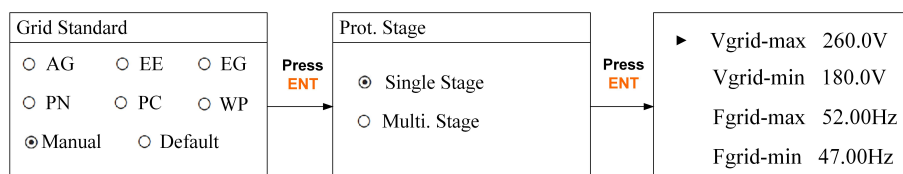

The multiple stage parameters are as follows.

▶ 1-V <sub>max</sub> 260.0V 1-Time 002.00s 2-V <sub>max</sub> 265.0V 2-Time 000.20s	▶ 1-V <sub>min</sub> 180.0V 1-Time 002.00s 2-V <sub>min</sub> 180.0V 2-Time 002.00s	▶ 1-F <sub>max</sub> 52.00Hz 1-Time 000.20s 2-F <sub>max</sub> 52.00Hz 2-Time 000.20s	▶ 1-F <sub>min</sub> 47.00Hz 1-Time 001.50s 2-F <sub>min</sub> 47.00Hz 2-Time 001.50s
--	--	--	--

**For the Country "BRA"**

Select the grid type and set the protective parameters.

Country	Grid Grade	Prot. Stage	▶ V <sub>grid-max</sub> 242.0V V <sub>grid-min</sub> 176.0V F <sub>grid-max</sub> 62.00Hz F <sub>grid-min</sub> 57.50Hz
Country: [ BRA ]	<input checked="" type="radio"/> 220V <input type="radio"/> 240V	<input checked="" type="radio"/> Single Stage <input type="radio"/> Multi. Stage	

**Table 7-4** Default Parameters for Brazil

Parameter	Explanation	Default/Range	
		220 V Grid	240 V Grid
V <sub>grid-max</sub> (V)	Grid overvoltage protection value	242.0 (230.0 – 299.0)	264.0 (230.0 – 299.0)
V <sub>grid-min</sub> (V)	Grid undervoltage protection value	176.0 (46.0 – 230.0)	192.0 (46.0 – 230.0)
F <sub>grid-max</sub> (Hz)	Grid overfrequency protection value	62.00 / (60.00 – 65.00)	
F <sub>grid-min</sub> (Hz)	Grid underfrequency protection value	57.50 / (55.00 – 60.00)	

\* The values listed in the table are for your reference only. Please follow local grid requirements.

**For the Country "TH"**

Select the grid standard and set the protective parameters.

**Table 7-5** Default Parameters for Thailand

Parameter	Default/Range	
	220 V Grid	230 V Grid
1-V <sub>max</sub> (V)	242.0	239.2
1-Time (s)	1.0	2.0
1-V <sub>max</sub> (V)	264.0	310.5
2-Time (s)	0.16	0.05
1-V <sub>min</sub> (V)	198.0	200.1
1-Time (s)	2.0	2.0
1-V <sub>min</sub> (V)	110.0	115.0
2-Time (s)	0.3	0.1
1-F <sub>max</sub> (V)	52.00	52.00

Parameter	Default/Range	
	220 V Grid	230 V Grid
1-Time (s)	0.1	0.1
1-F <sub>max</sub> (V)	52.00	52.00
2-Time (s)	0.1	0.1
1-F <sub>min</sub> (V)	47.00	47.00
1-Time (s)	0.1	0.1
1-F <sub>min</sub> (V)	47.00	47.00
2-Time (s)	0.1	0.1

\* Refer to "Table 10-9 Description of Multi. Stage Protective Parameters" for the parameter explanations. The values listed in the table are for your reference only. Please follow local grid requirements. The parameters can only be set via the iSolarCloud App or the iSolarCloud server.

For Countries except "AU", "NZ", "BRA" and "TH"

Press ▲/▼ to select the grid standard and Press ENT to confirm. Take Germany "DE" for reference in the figure.

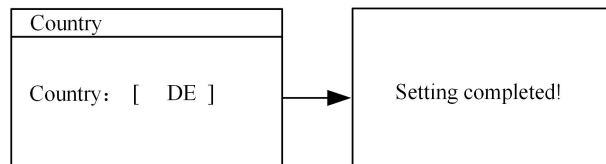

#### 7.4.2 Adding the Existing Inverter

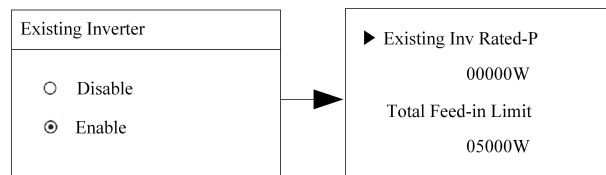

- **Existing Inv Rated-P:** rated power of the existing inverter.
- **Total Feed-in Limit:** feed-in power limit of the new system.

The total feed-in limit ranges from (rated power of the existing inverter) to ((rated power of the hybrid inverter) + [rated power of the existing inverter]). For example, retrofit an existing PV system (rated power: 3000 W) with SH5K-30 hybrid inverter (rated power: 5000 W). The total feed-in limit can be set from 3000 W to 8000 W.

The feed-in power limit setting and zero-export setting are from the same source. If one is changed, the other will synchronize the value.

### 7.4.3 Setting Feed-in Power

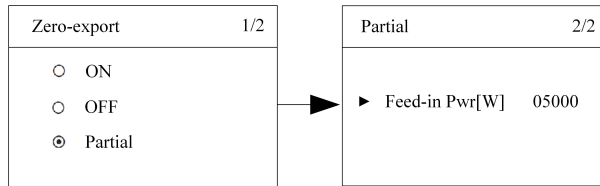

- **ON:** no power could be fed into the grid.
- **OFF:** all system output power could be fed into the grid.
- **Partial:** partial of the output power could be fed into the grid.
  - When the existing system is disabled, the feed-in power ranges from 0 to the rated power of the existing system.
  - When the existing system is enabled, the feed-in power ranges from (rated power of the existing system) to ([rated power of the hybrid inverter] + [rated power of the existing system]).

#### NOTICE

According to the local regulations in Germany, please set the feed-in power to 70 % of the installation capacity.

For example, with a total maximum installation capacity of 4600 W (SH4K6-30), the feed-in power should be set to 3220 W (i.e.  $4600 * 70\%$ ).

### 7.4.4 Setting System Time

The correct system time is very important. Wrong system time will directly affect the data logging and power generation value. The clock is in 24-hour format.

▶ Time	hh : mm : ss 15 : 26 : 00
Date	DD / MM / YY 20 / 07 / 19

- DD, MM, and YY stand for day, month, and year respectively.
- hh, mm, and ss stand for hour, minute, and second respectively.

### 7.4.5 Setting Backup Function

The backup function is disabled by default.

If the backup function is enabled, you should set the reserved capacity for Li-ion batteries.

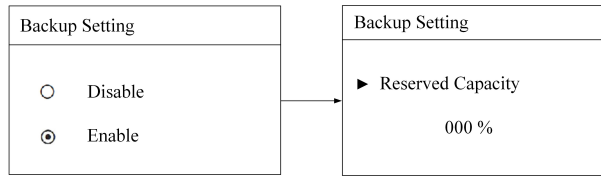

#### 7.4.6 Setting Reactive Power Regulation ("DE")

**OFF:** The reactive power regulation function is disabled. The power factor (PF) is limited to +1.000.

**PF:** The inverter is capable of operating with fixed power factor. The PF ranges from 0.8 leading to 0.8 lagging.

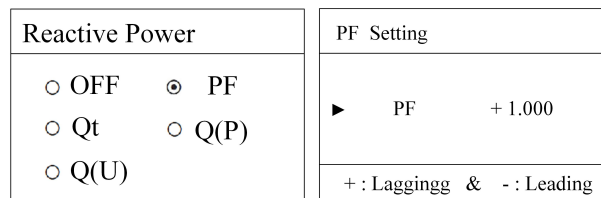

- **Leading:** the inverter is sourcing reactive power to the grid.
- **Lagging:** the inverter is sinking reactive power from the grid.

For the explanations of other modes, see "[11 Appendix II: Reactive Power Regulation](#)".

#### 7.4.7 Initializing

- 1 If all the items are successfully completed, select "Exit" to quit the initial setting.

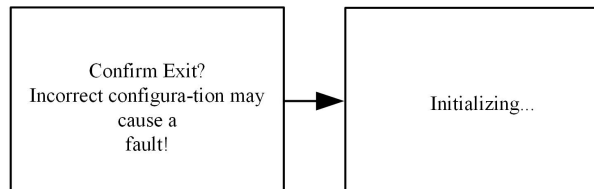

- 2 Check and confirm the communication method. Refer to "[10.4.13 Setting the Communication Parameters](#)" for the communication configuration. Use the iSolarCloud App to create a new plant. For details, refer to the user guidance of iSolarCloud App.

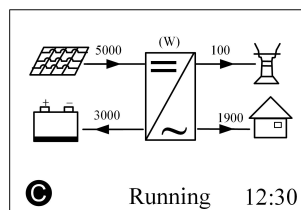

- 3 Check the icons on the main screen. Refer to "[10.1 Main Screen](#)" for the explanations.
- 4 Check the status of the LED indicator according to the following table.

**Table 7-6** State Descriptions of the LED Indicator

Color	Status	Description
Green	On	The inverter is running normally.
	Blinking	The inverter is in the process of starting.
	Off	Other states except Running and Starting. (Refer to "Table 10-1 State Descriptions" for state descriptions.)
Red	On	Permanent fault or upgrade failure.
	Blinking	Other system faults or main alarms.
	Off	No fault occurs.

- 5 Visit [www.iSolarCloud.com](http://www.iSolarCloud.com) or iSolarCloud App to view inverter information. Get the related manuals at [support.sungrowpower.com](http://support.sungrowpower.com).
- 6 If the inverter commissioning fails, Press ▼ to view the active errors. Remove the existing malfunctions and then repeat starting up the inverter according to the procedure detailed in this section.

Error Active	PI/I
001 GRID	008

## 7.5 Result Verification

### 7.5.1 Energy Meter Installation and Connection

#### For Incorrect Installation Position

Make sure that the 1-phase sensor of the Sungrow Energy Meter should be placed to the phase line (L) from the main switch. If otherwise, the energy flow indicated on the LCD will be wrong.

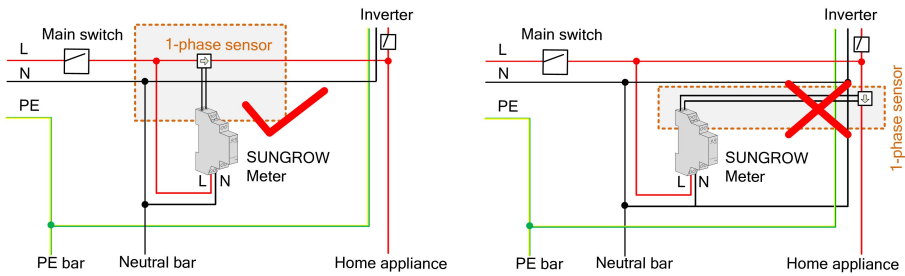

Figure 7-2 Installation Position for Single-phase Energy Meter

Action	LCD Explanation
<p>Turn off all the household loads.</p> <p>All the PV power generation should be fed into the grid, as shown in the “Correct” figure.</p>	<div style="display: flex; justify-content: space-around;"> <div style="text-align: center;"> <p>Correct</p> </div> <div style="text-align: center;"> <p>Wrong</p> </div> </div>

**For Reverse Sensor Connection**

Make sure that the arrow on the 1-phase sensor must point away from the grid towards the load. If otherwise, the energy flow indicated on the LCD will be wrong.

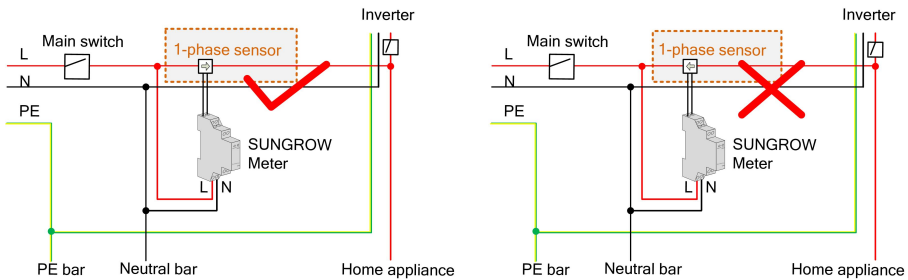

Figure 7-3 Correct CT Installation for Single-phase Energy Meter



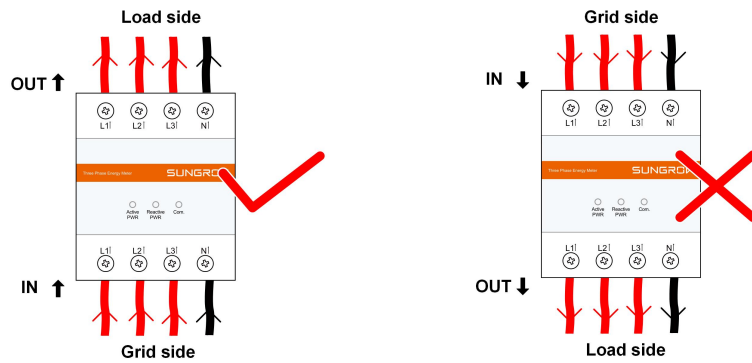

Figure 7-4 Correct Power cable connection for Three-phase Meter

Action	LCD Explanation		
<p>Method 1:</p> <p>Turn off all the household loads.</p> <p>All the PV power generation should be fed into the grid, as shown in the “Correct” figure.</p>	<table border="0"> <tr> <td style="text-align: center;"> <p>Correct</p> </td> <td style="text-align: center;"> <p>Reverse</p> </td> </tr> </table>	<p>Correct</p>	<p>Reverse</p>
<p>Correct</p>	<p>Reverse</p>		
<p>Method 2:</p> <p>Stop the inverter via the LCD menu and turn on the household loads.</p> <p>All the load power consumption should be imported from the grid, as shown in the “Correct” figure.</p>	<table border="0"> <tr> <td style="text-align: center;"> <p>Correct</p> </td> <td style="text-align: center;"> <p>Reverse</p> </td> </tr> </table>	<p>Correct</p>	<p>Reverse</p>
<p>Correct</p>	<p>Reverse</p>		

**NOTICE**

The reverse sensor connection will cause the communication fault 084. To clear the fault 084, please turn off the DC sources and then restart the system after reconnecting the sensor in correct direction.

### 7.5.2 Battery Information

After initial settings, check the detailed battery information on the LCD display.

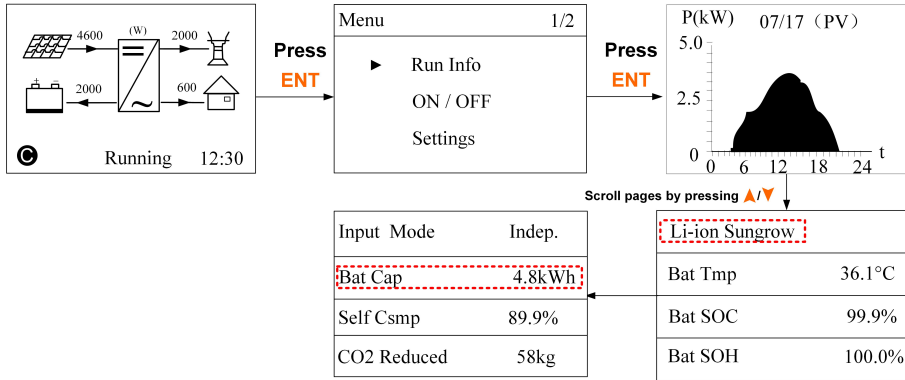

If the battery type or capacity setting is inconsistent with the actual, the charge/discharge current may be less than the actual charge/discharge ability. However, the system can operate normally.

Please stop the inverter via the LCD menu. Reset the battery type and parameters and then start the inverter again.

### 7.5.3 System Time

The correct system time is very important. If there is deviation between the system time and the local time, the inverter will not operate normally. The clock is in 24-hour format. Proceed as follows to set the correct time.

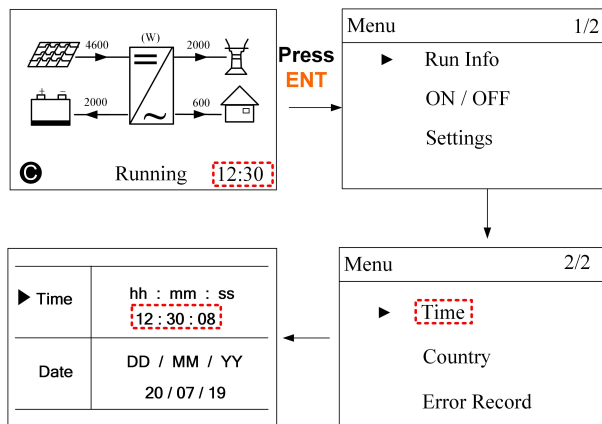

# 8 System Decommissioning

## 8.1 Decommissioning the Inverter

### NOTICE

Please strictly follow the following procedure. Otherwise it will cause lethal voltages or unrecoverable damage to the inverter.

### 8.1.1 Disconnecting the Inverter

For maintenance or other service work, the inverter must be switched off.

Proceed as follows to disconnect the inverter from the AC and DC power sources. Lethal voltages or damage to the inverter will follow if otherwise.

**Step 1** Stop the inverter via the LCD menu. For details, see "[10.3 Starting and Stopping the Inverter](#)".

**Step 2** Disconnect the external AC circuit breaker and secure it against reconnection.

**Step 3** Rotate the DC switches to the "OFF" position for disconnecting all of the PV string inputs

**Step 4** Wait about **10** minutes until the capacitors inside the inverter completely discharge.

**Step 5** Ensure that the DC cable is current-free via a current clamp.

**Step 6** Insert a MC4 wrench into the notch and press the wrench with an appropriate force to remove the DC connector.

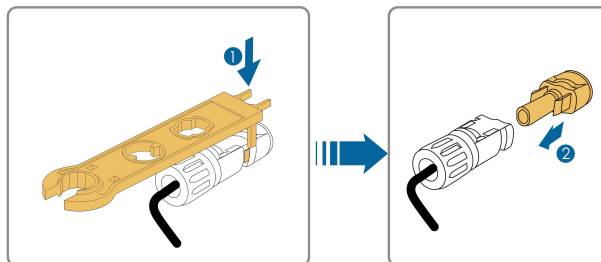

**Step 7** Ensure that the AC wiring terminals are voltage-free via a multimeter, and remove the AC wires and communication wires.

**Step 8** Install the MC4 waterproof plugs.



For further disconnection and reconnection instructions, please visit the webpage of respective component manufacturer.

-- End

### 8.1.2 Dismantling the Inverter

#### **⚠ CAUTION**

Risk of burn injuries and electric shock!

Do not touch any inner live parts until for at least 10 minutes after disconnecting the inverter from the utility grid and the PV input.

**Step 1** Refer to "[6 Electrical Connection](#)" for the inverter disconnection of all cables in reverse steps.

**Step 2** Dismantle the inverter referring to "[5 Mechanical Mounting](#)" in reverse steps.

**Step 3** If necessary, remove the wall-mounting bracket from the wall.

**Step 4** If the inverter will be reinstalled in the future, please refer to "[4.4 Inverter Storage](#)" for a proper conservation.

-- End

### 8.1.3 Disposal of the Inverter

Users take the responsibility for the disposal of the inverter.

#### **NOTICE**

Some parts and devices of the inverter, such as the capacitors, may cause environmental pollution.

Do not dispose of the product together with household waste but in accordance with the disposal regulations for electronic waste applicable at the installation site.

## 8.2 Decommissioning the Battery

Decommission the battery in the system after the inverter is decommissioned, following the steps for a Li-ion battery or lead-acid battery below. SUNGROW is not liable for disposal of the battery.

### **Decommissioning Li-ion Battery**

- 1 Disconnect the DC circuit breaker between the battery and the inverter.
- 2 Disconnect the communication cable between the battery and the inverter.
- 3 **(Optional)** Turn off the switch on the battery if applicable.
- 4 Wait about 1 minute and use the multimeter to measure the port voltage of the battery.

- 5 If the battery port voltage is zero, disconnect the power cables between the battery and the inverter.

**Decommissioning Lead-acid Battery**

- 1 Disconnect the DC switch between the battery and the inverter.
- 2 Turn off the switch on the battery.
- 3 Disconnect all the cables between the battery and the inverter.

# 9 Troubleshooting and Maintenance

## 9.1 Troubleshooting

### 9.1.1 Troubleshooting of the LED Indicator

See "Table 7-6 State Descriptions of the LED Indicator" for the definition.

Fault Type	Troubleshooting
The LED indicator and LCD screen cannot be lit.	<ol style="list-style-type: none"><li>1 Disconnect the AC circuit breaker.</li><li>2 Rotate the DC Switch to "OFF".</li><li>3 Check the polarities of the DC inputs.</li></ol>
The LED indicator goes out.	<ol style="list-style-type: none"><li>1 Disconnect the AC circuit breaker.</li><li>2 Rotate the DC Switch to "OFF".</li><li>3 Check the electrical connection.</li><li>4 Check whether the DC input voltage exceeds the start voltage of the inverter.</li><li>5 If all of the above are OK, please contact SUNGROW.</li></ol>
The LED indicator is lit red.	<ol style="list-style-type: none"><li>1 A fault is not resolved.</li><li>2 Perform troubleshooting according to the fault type on the LCD screen. See "9.1.2 Troubleshooting of the Errors".</li><li>3 If it cannot be resolved, please contact SUNGROW.</li></ol>

### 9.1.2 Troubleshooting of the Errors

When an error occurs, the "Error" state will be shown on the main screen. Press ▼ to view detailed error information.



- For the battery error codes, if all the conditions are OK but the error still occurs, contact the distributor or the battery manufacturer.
- We need the following information to provide you with the best assistance: inverter type (e.g. string, central, grid-connected, hybrid, transformerless, single phase, triple phase, single MPPT, multiple MPPTs), or product name, serial number of the inverter, error code/name, and a brief description of the issue.

## For Inverter Side

Error Code	Description	Troubleshooting
002	Grid overvoltage. The grid voltage exceeds the set protection value. (stage I)	<p>Generally, the inverter will be reconnected to the grid after the grid recovers. If the fault occurs repeatedly:</p> <ol style="list-style-type: none"> <li>1. Measure the actual grid voltage, and contact the local utility grid company for solutions if the grid voltage exceeds the specified value.</li> <li>2. Check whether the protection parameters are appropriately set via the App or the LCD.</li> <li>3. Check whether the cross-sectional area of the AC cable meets the requirement.</li> <li>4. If the error persists, contact SUNGROW.</li> </ol>
003	Grid transient overvoltage (on-grid mode). The transient grid voltage exceeds inverter allowable upper limit.	<ol style="list-style-type: none"> <li>1. Generally, the inverter will be reconnected to the grid after the grid recovers.</li> <li>2. If the error persists, contact SUNGROW.</li> </ol>
004	Grid undervoltage. The grid voltage is lower than the set protection value. (stage I)	<p>Generally, the inverter will be reconnected to the grid after the grid recovers. If the fault occurs repeatedly:</p> <ol style="list-style-type: none"> <li>1. Measure the actual grid voltage, and contact the local utility grid company for solutions if the grid voltage is lower than the set value.</li> <li>2. Check whether the protection parameters are appropriately set via the App or the LCD.</li> <li>3. Check whether the AC cable is firmly in place.</li> <li>4. If the error persists, contact SUNGROW.</li> </ol>
005	Grid undervoltage. The grid voltage is below the protective value, which is lower than the protective value of error 004. (stage II)	<ol style="list-style-type: none"> <li>1. Generally, the inverter will be reconnected to the grid after the grid recovers.</li> <li>2. If the error persists, contact SUNGROW.</li> </ol>
007	Transient AC overcurrent. The transient AC current has exceeded the allowable upper limit.	<ol style="list-style-type: none"> <li>1. Generally, the inverter will be reconnected to the grid after the grid recovers.</li> <li>2. If the error persists, contact SUNGROW.</li> </ol>

Error Code	Description	Troubleshooting
008	Grid overfrequency. The grid frequency exceeds the upper limit of the inverter. (stage I)	Generally, the inverter will be reconnected to the grid after the grid recovers. If the fault occurs repeatedly: 1. Measure the actual grid frequency, and contact the local utility grid company for solutions if the grid frequency is beyond the set range.
009	Grid underfrequency. The grid frequency is lower than the lower limit of the inverter. (stage I)	2. Check whether the protection parameters are appropriately set via the App or the LCD. 3. If the error persists, contact SUNGROW.
010	Grid failure (Islanding). Abnormal connection between the system and the grid.	Generally, the inverter will be reconnected to the grid after the grid recovers. If the fault occurs repeatedly: 1. Check whether the grid supplies power reliably. 2. Check whether the AC cable is firmly in place. 3. Check whether the AC cable is connected to the correct terminal (whether the live wire and the N wire are correctly in place). 4. Check whether the AC circuit breaker is connected. 5. If the error persists, contact SUNGROW.
011	DC injection overcurrent. The DC injection of the AC current exceeds the upper limit.	1. Wait 5 minutes for the inverter to recover. 2. Disconnect the AC and DC switches, and reconnect the AC and DC switches 15 minutes later to restart the inverter. 3. If the error persists, contact SUNGROW.
012	Excessive leakage current. The leakage current exceeds the upper limit.	1. The fault can be caused by poor sunlight or damp environment, and the inverter will be reconnected to the grid after the environment is improved. 2. If the environment is normal, check whether the AC and DC cables are well insulated. 3. If the error persists, contact SUNGROW.



Error Code	Description	Troubleshooting
014	10-minute grid overvoltage. The average grid voltage in 10 minutes exceeds the upper limit.	<ol style="list-style-type: none"> <li>1. Wait 5 minutes for the inverter to recover.</li> <li>2. Check whether the grid is operating normally.</li> <li>3. If the error persists, contact SUNGROW.</li> </ol>
015	Grid overvoltage. The grid voltage exceeds the protective value, which is higher than the protective value of error 002. (stage II)	<p>Generally, the inverter will be reconnected to the grid after the grid recovers. If the fault occurs repeatedly:</p> <ol style="list-style-type: none"> <li>1. Measure the actual grid voltage, and contact the local utility grid company for solutions if the grid voltage is higher than the set value.</li> <li>2. Check whether the protection parameters are appropriately set via the App or the LCD.</li> <li>3. Check whether the cross-sectional area of the AC cable meets the requirement.</li> <li>4. If the error persists, contact SUNGROW.</li> </ol>
019	Bus transient overvoltage. The transient bus voltage exceeds the upper limit.	<ol style="list-style-type: none"> <li>1. Wait 5 minutes for the inverter to recover or restart the system.</li> <li>2. If the error persists, contact SUNGROW.</li> </ol>
021	PV1 input overcurrent. The input current of PV1 exceeds the upper limit.	<ol style="list-style-type: none"> <li>1. Check the PV input power and configuration.</li> </ol>
022	PV2 input overcurrent. The input current of PV2 exceeds the upper limit.	<ol style="list-style-type: none"> <li>2. Wait 5 minutes for the inverter to recover or restart the system.</li> <li>3. If the error persists, contact SUNGROW.</li> </ol>
024	Neutral point voltage imbalance. The deviation of the neutral point voltage exceeds the allowable limit.	<ol style="list-style-type: none"> <li>1. The inverter will recover once the deviation falls below the protective limit.</li> <li>2. Wait 5 minutes for the inverter to recover or restart the system.</li> </ol>
028	Reverse polarity of the PV1 connection.	<ol style="list-style-type: none"> <li>1. Disconnect the DC switch.</li> <li>2. Check the polarity of the PV inputs.</li> </ol>
029	Reverse polarity of the PV2 connection.	<ol style="list-style-type: none"> <li>3. Reconnect the PV strings if the polarity is incorrect.</li> </ol>

Error Code	Description	Troubleshooting
037	Temperature anomaly. The temperature of the interior of the inverter is excessively high and out of the safe range.	<ol style="list-style-type: none"> <li>1. Check whether the inverter is directly exposed to sunlight or the ambient temperature of the enclosure exceeds 45°C. If so, take some shading measures.</li> <li>2. Check and clean the heat sink.</li> <li>3. If the error persists, contact SUNGROW.</li> </ol>
038	Relay fault on the grid side.	<ol style="list-style-type: none"> <li>2. Wait 5 minutes for the inverter to recover or restart the system.</li> <li>3. If the error persists, contact SUNGROW.</li> </ol>
039	Low system insulation resistance, which is generally caused by poor insulation to ground of the module/cable or by rainy and damp environment.	<p>Wait for the inverter to recover. If the fault occurs repeatedly:</p> <ol style="list-style-type: none"> <li>1. Check whether the ISO resistance protection value is excessively high via the App or the LCD, and ensure that it complies with the local regulations.</li> <li>2. Check the resistance to ground of the string and DC cable. Take correction measures in case of short circuit or damaged insulation layer.</li> <li>3. If the cable is normal and the fault occurs on rainy days, check it again when the weather turns fine.</li> <li>4. If the error persists, contact SUNGROW.</li> </ol>
041, 622	Leakage current sampling fault.	<ol style="list-style-type: none"> <li>1. Wait 5 minutes for the inverter to recover or restart the system.</li> <li>2. If the error persists, contact SUNGROW.</li> </ol>
043	Inner under-temperature fault. The ambient temperature inside the inverter is too low.	The inverter will recover once the ambient temperature rises above -25°C.
044	INV open-loop self-check fault.	<ol style="list-style-type: none"> <li>1. Wait 5 minutes for the inverter to recover or restart the system.</li> <li>2. If the error persists, contact SUNGROW.</li> </ol>
045	PV1 boost circuit fault.	1. Wait 5 minutes for the inverter to recover or restart the system.
046	PV2 boost circuit fault.	2. If the error persists, contact SUNGROW.

Error Code	Description	Troubleshooting
048	Phase current sampling fault.	
051	Load overpower fault in the off-grid mode.	If the error persists, disconnect some non-key loads.
052	INV undervoltage fault in the off-grid mode.	1. Wait 5 minutes for the inverter to recover or restart the system. 2. If the error persists, contact SUNGROW.
063	The version of CPLD (- complex programmable logic device) cannot be detected.	Power off the system and program the CPLD.
064	INV overvoltage fault in the off-grid mode.	
065	INV under-frequency fault in the off-grid mode.	1. Wait 5 minutes for the inverter to recover or restart the system.
066	INV overfrequency fault in the off-grid mode.	2. If the error persists, contact SUNGROW.
067	Transient grid overvoltage in the off-grid mode.	
075	RS485 communication error between two inverters in parallel.	1. Check the RS485 cable connection. 2. Check whether the parallel settings of two inverters are enabled and they are set to master and slave respectively via the LCD menu.
083	Fan2 abnormal speed warning.	1. Check if the fan is blocked. 2. Restart the system.
084	Warning for reverse cable connection of the Sungrow Smart Energy Meter.	1. Check whether the power cable connections are correct. 2. For Sungrow single-phase Smart Energy Meter, check whether the CT clamp of the 1-phase sensor is correctly placed. Refer to <a href="#">"7.5.1 Energy Meter Installation and Connection"</a> .
100	INV hardware overcurrent fault. The AC current exceeds the protective value.	1. Wait 5 minutes for the inverter to recover or restart the system. 2. If the error persists, contact SUNGROW.

Error Code	Description	Troubleshooting
101	Grid overfrequency. The grid frequency exceeds the protective value, which is higher than the protective value of error 008. (stage II)	Generally, the inverter will be reconnected to the grid after the grid recovers. If the fault occurs repeatedly:  1. Measure the actual grid frequency, and contact the local utility grid company for solutions if the grid frequency is beyond the set range.
102	Grid underfrequency. The grid frequency is below the protective value, which is lower than the protective value of error 009. (stage II)	2. Check whether the protection parameters are appropriately set via the App or the LCD. 3. If the error persists, contact SUNGROW.
106	The inverter is not grounded. Neither the PE terminal on the AC connection block nor the second PE terminal on the enclosure is reliably connected.	1. Check whether there is a reliable grounding connection. 2. Check whether the L-line and N-line are connected correctly. 3. If there is an access to the ground, and the error persists, please contact SUNGROW for a solution.
107	DC injection overvoltage fault in the off-grid mode. The DC injection of INV voltage exceeds the upper limit.	The inverter will recover once the DC injection voltage falls below the recovery value.
113	Temporary bypass overcurrent.	1. Check whether the power of emergency loads exceeds the upper limit of the BACKUP port. 2. Wait a moment for inverter recovery or restart the system. 3. If the error persists, please contact SUNGROW for a solution.
200	Bus hardware overvoltage fault. The bus voltage exceeds the protection value.	1. Wait 5 minutes for the inverter to recover or restart the system. 2. If the error persists, contact SUNGROW.
201	Bus undervoltage fault.	

Error Code	Description	Troubleshooting
202	PV hardware overcurrent fault. The PV1 or PV2 current exceeds the protective value.	
203	The PV input voltage exceeds the bus voltage.	Check the functionality of the PV connection terminals.
204	PV1 boost short-circuit fault	The inverter may be damaged. Contact SUNGROW for a solution.
205	PV2 boost short-circuit fault	
300	INV overtemperature fault.	<ol style="list-style-type: none"> <li>1. Check and clean the heat sink.</li> <li>2. Check whether the inverter is installed in sunlight or the ambient temperature of the enclosure exceeds 45°C-60°C.</li> <li>3. Restart the system.</li> </ol>
303	Bypass relay fault.	1. Wait 5 minutes for the inverter to recover or restart the system.
304	Off-grid relay fault.	2. If the error persists, contact SUNGROW.
308	Slave DSP redundant fault.	Restart the system.
309	Phase voltage sampling fault.	
312	DC injection sampling fault.	
315	PV1 current sampling fault.	
316	PV2 current sampling fault.	
317	PV1 MPPT current sampling fault.	
318	PV2 MPPT current sampling fault.	
319	System power supply failure fault.	
320	Leakage current CT self-check fault.	

Error Code	Description	Troubleshooting
321	SPI communication failure. Communication faults between the master DSP and the slave DSP.	
322	Master DSP communication fault.	
401-408	Permanent faults.	Restart the system.
409	All temperature sensors failed fault.	Forced restart the system.
501	FRAM1 reading warning.	
503-506, 511	Temperature sensor warnings.	1. Inverter can normally be connected to the grid. 2. Restart the system.
507	Error alarm of DO power settings.	Modify the DO power according to the load power. Refer to " <a href="#">Optimized Control</a> ".
509	Clock reset fault.	Manually reset the clock or synchronize the clock with the network time. This will clear the fault.
510	PV overvoltage fault.	1. Check whether the configuration of the PV strings exceeds the permissible range of the inverter. 1. Wait 5 minutes for the inverter to recover or restart the system.
513	Fan1 abnormal speed warning.	1. Check if the fan is blocked. 2. Restart the system.
514	Abnormal communication warning of the Sungrow Meter. (Inverter can be normally connected to the grid.)	1. Check whether the power cable connections of the meter are correct. 2. Check whether the RS485 connection is correct. 3. Check if the 120 Ohm (2) resistor for RS485_2 is pushed to "ON" when the length of RS485 cable is longer than 100 m.
600	Transient BDC charging overcurrent fault.	1. Wait 5 minutes for the inverter to recover or restart the system. 2. If the error persists, contact SUNGROW.

Error Code	Description	Troubleshooting
601	Transient BDC discharging overcurrent fault.	
603	Transient clamping capacitor overvoltage fault.	
608	BDC circuit self-check fault.	
612	BDC overtemperature fault.	<ol style="list-style-type: none"> <li>1. Check and clean the heat sink.</li> <li>2. Check whether the inverter is installed in sunlight or the ambient temperature of the enclosure exceeds 45°C.</li> <li>3. Restart the system.</li> </ol>
616	BDC hardware overcurrent fault.	The system will resume once the battery charge/discharge current falls below the upper limit or restart the system.
620	BDC current sampling fault.	1. Wait 5 minutes for the inverter to recover or restart the system.
623	Slave DSP communication fault.	2. If the error persists, contact SUNGROW.
624	BDC soft-start fault.	
800, 802, 804, 807	BDC internal permanent faults.	Restart the inverter.
900,901	BDC temperature sensor warnings	<ol style="list-style-type: none"> <li>1. Check and clean the heat sink.</li> <li>2. Check whether the inverter is installed in sunlight or the ambient temperature of the enclosure exceeds 45°C.</li> <li>3. Restart the system.</li> </ol>
910	FRAM2 warning	Restart the system.

### For Battery Side

For the battery faults, please consult the battery manufacturer for a solution.

Error Code	Description	Troubleshooting
703	Battery average undervoltage fault.	<ol style="list-style-type: none"> <li>1. The inverter can normally be connected to the grid but charge/discharge has stopped.</li> <li>2. Wait a moment for system recovery or restart the system.</li> </ol>
707	Battery overtemperature fault.	<ol style="list-style-type: none"> <li>1. The inverter can normally be connected to the grid but charge/discharge has stopped.</li> <li>2. Check the ambient temperature of the battery location.</li> </ol>
708	Battery undertemperature fault.	<ol style="list-style-type: none"> <li>3. Wait a moment for system recovery or restart the system.</li> </ol>
711	Instantaneous battery overvoltage.	<ol style="list-style-type: none"> <li>1. The inverter can normally be connected to the grid but charge/discharge has stopped.</li> </ol>
712	Battery average overvoltage fault.	<ol style="list-style-type: none"> <li>2. Wait a moment for system recovery or restart the system.</li> </ol>
714	Abnormal communication between battery and the hybrid inverter.	<ol style="list-style-type: none"> <li>1. The inverter can normally be connected to the grid but charge/discharge has stopped.</li> <li>2. Check the battery type and communication connection. For lead-acid batteries, you should manually set the battery type. Refer to <a href="#">"10.4.5 Setting Battery Type"</a>.</li> <li>3. Wait a moment for system recovery or restart the system.</li> </ol>
715	Battery hardware overvoltage fault.	<ol style="list-style-type: none"> <li>1. The inverter can normally be connected to the grid but charge/discharge has stopped.</li> <li>2. Wait a moment for system recovery or restart the system.</li> </ol>
732	Battery overvoltage protection.	<ol style="list-style-type: none"> <li>1. The inverter can normally be connected to the grid. Charge has stopped but discharge is allowed.</li> <li>2. Wait a moment for system recovery.</li> </ol>
733	Battery overtemperature protection.	<ol style="list-style-type: none"> <li>1. The inverter can normally be connected to the grid but charge/discharge has stopped.</li> </ol>
734	Battery undertemperature protection.	<ol style="list-style-type: none"> <li>2. Check the ambient temperature of the battery location.</li> <li>3. Wait a moment for system recovery or restart the system.</li> </ol>



Error Code	Description	Troubleshooting
735	Battery charging/ discharging overcurrent protection.	<ol style="list-style-type: none"> <li>1. The inverter can normally be connected to the grid but charge/discharge has stopped.</li> <li>2. Wait a moment for system recovery or restart the system.</li> </ol>
739	Battery undervoltage protection.	<ol style="list-style-type: none"> <li>1. The inverter can normally be connected to the grid. Discharge has stopped but charge is allowed.</li> <li>2. Wait a moment for system recovery or restart the system.</li> </ol>
832	Battery FET fault or electrical switch failure.	<ol style="list-style-type: none"> <li>1. The inverter can normally be connected to the grid but charge/discharge has stopped.</li> <li>2. Check the battery port voltage and the battery communication cable connection.</li> </ol>
834	Battery charging/ discharging overcurrent permanent fault.	<ol style="list-style-type: none"> <li>3. Force a shutdown and restart the inverter and battery system.</li> <li>4. Wait a moment for system recovery or restart the system.</li> </ol>
836	CAN ID competing failure.	Restart the system, if the fault persists, please contact SUNGROW for a solution.
839	Mismatched software version.	Contact SUNGROW for a solution.
844	Software self-verifying failure.	Restart the system, if the error persists, please contact SUNGROW for a solution.
864	Battery cell overvoltage fault.	<ol style="list-style-type: none"> <li>1. The inverter can normally be connected to the grid but charge/discharge has stopped.</li> <li>2. Wait a moment for system recovery or restart the system.</li> </ol>
866	Battery precharge voltage fault.	1. The inverter can normally be connected to the grid but charge/discharge has stopped.
867	Battery undervoltage fault.	2. Check the battery port voltage and the communication cable connection.
868	Battery cell voltage imbalance fault.	3. Force a shutdown and restart the inverter and battery system.
870	Battery cable connection fault.	4. Wait a moment for system recovery or restart the system.

Error Code	Description	Troubleshooting
909	Low SOH (State of Health) warning.	<ol style="list-style-type: none"> <li>1. The inverter can normally be connected to the grid and the charge/discharge function is normal.</li> <li>2. Batteries are beyond the scope of the warranty. It is recommended to contact the distributor for replacements.</li> </ol>
932	Battery overvoltage warning.	<ol style="list-style-type: none"> <li>1. The inverter can normally be connected to the grid. Charge has stopped but discharge is allowed.</li> <li>2. The system will resume after a certain time of discharging.</li> </ol>
933	Battery overtemperature warning.	<ol style="list-style-type: none"> <li>1. The inverter can normally connected be to the grid but charge/discharge has stopped.</li> <li>2. Check the ambient temperature of the battery location.</li> </ol>
934	Battery undertemperature warning.	<ol style="list-style-type: none"> <li>3. Wait a moment for system recovery or restart the system.</li> </ol>
935	Battery charging/ discharging overcurrent warning.	<ol style="list-style-type: none"> <li>1. The inverter can normally be connected to the grid but charge/discharge has stopped.</li> <li>2. Wait a moment for system recovery or restart the system.</li> </ol>
937	Battery tray voltage imbalance warning.	<ol style="list-style-type: none"> <li>1. The inverter can normally be connected to the grid and the charge/discharge functions are normal.</li> <li>2. Check whether the cable connection of the battery is correct.</li> </ol>
939	Battery undervoltage warning.	<ol style="list-style-type: none"> <li>1. The inverter can normally be connected to the grid. Discharge has stopped but charge is allowed.</li> <li>2. The system will resume after a certain time of charging.</li> </ol>
964	Battery internal warning.	Consult the battery manufacturer for a solution.

## 9.2 Maintenance

### DANGER

Risk of inverter damage or personal injury due to incorrect service!

- Always keep in mind that the inverter is powered by multiple sources: PV strings, battery and utility grid.

Before any service work, observe the following procedure.

- Disconnect the AC circuit breaker and then set the DC load-break switch of the inverter to OFF;
- Wait at least 10 minutes for inner capacitors to discharge completely;
- Verify that there is no voltage or current before pulling any connector.

### CAUTION

Keep non-related persons away!

A temporary warning sign or barrier must be posted to keep non-related persons away while performing electrical connection and service work.

### NOTICE

Restart the inverter only after removing the fault that impairs safety performance.

As the inverter contains no component parts that can be maintained, never arbitrarily replace any internal components.

For any maintenance need, please contact SUNGROW. Otherwise, SUNGROW shall not be held liable for any damage caused.



Servicing of the device in accordance with the manual should never be undertaken in the absence of proper tools, test equipments or the latest revision of the manual which has been clearly and thoroughly understood.

## 9.2.1 Maintenance

### DANGER

Risk of inverter damage or personal injury due to incorrect service!

Always keep in mind that the inverter is powered by dual sources: PV strings and utility grid.

Before any service work, observe the following procedure.

- Disconnect the AC circuit breaker and then set the DC load-break switch of the inverter to OFF;
- Wait at least 10 minutes for inner capacitors to discharge completely;
- Verify that there is no voltage or current before pulling any connector.

### CAUTION

Keep non-related persons away!

A temporary warning sign or barrier must be posted to keep non-related persons away while performing electrical connection and service work.

### NOTICE

- Restart the inverter only after removing the fault that impairs safety performance.
- As the inverter contains no component parts that can be maintained, never arbitrarily replace any internal components.
- For any maintenance need, please contact SUNGROW. Otherwise, SUNGROW shall not be held liable for any damage caused.

Item	Method	Period
System clean	Check the temperature and dust of the inverter. Clean the inverter enclosure if necessary.	Six months to a year (- depend on the dust contents in air.)
	Check if the air inlet and outlet are normal.	
	Clean the air inlet and outlet, if necessary.	

## 9.2.2 Replacing the Button Battery

### DANGER

Disconnect the inverter from the grid first, then the PV strings and the battery before any maintenance work.

Lethal voltage still exists in the inverter. Please wait at least 10 minutes and then perform maintenance work.

There is a button battery on the inner PCB board of the LCD. Contact SUNGROW for replacement when the relevant fault alarm occurs.

Check the fastener, appearance, voltage, and resistance quarterly and annually.

# 10 Appendix I: LCD Operation

Refer to " Button Operations" for button operations when setting parameters.

## 10.1 Main Screen

After successful commissioning, the LCD screen will enter the main screen.

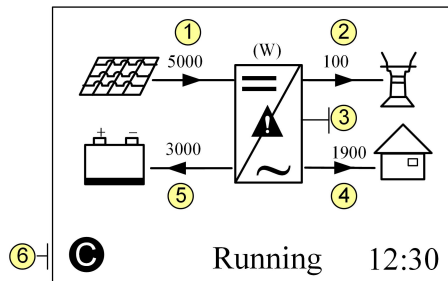

(1) Current PV input power	(2) Current feed-in power	(3) Warning information
(4) Total load consumption	(5) Battery charge/discharge power	(6) System status bar

The inverter and iSolarCloud server are successfully connected.

**Running:** The inverter is in its normal running state.

**12:30:** Current system time.

Neither the grid power nor the load power will be displayed on the main screen in case of no Smart Energy Meter installed.

If there is no button operation for:



- 1 minute, the LCD backlight is OFF;
- 2 minutes, system returns to the default menu (main screen).

Table 10-1 State Descriptions

State	Description
Running	After being energized, the inverter tracks the PV strings' maximum power point (MPP) and runs with the combination of the energy management system. This mode is the normal mode.
Maintain	The system is running normally, with the battery in maintenance process. (Only for lead-acid battery)
Forced	The system is running normally, with the EMS in forced mode.

Running	After being energized, the inverter tracks the PV strings' maximum power point (MPP) and runs with the combination of the energy management system. This mode is the normal mode.
Ext. EMS	The system is running normally and is controlled by external EMS.
Standby	The inverter waits for sufficient sunlight or battery level, then the DC voltage recovers. The standby time can be set on at <a href="http://www.iSolarCloud.com">www.iSolarCloud.com</a> .
Turn off	The inverter will stop running by manual "OFF" through the LCD menu or with the DRM0 command from the DRED. Set to "ON" if you want to restart the inverter.
Startup	The inverter is initializing and synchronizing with the grid.
Upgrade	The DSP or LCD software is in its upgrading process.
Error	If an error occurs, the inverter will automatically stop operation, trigger the AC relay and show "Error" on the LCD with the indicator lit. Once the error is removed in recovery time, the inverter will automatically resume running. The recovery time can be set at <a href="http://www.iSolarCloud.com">www.iSolarCloud.com</a> .
Off-grid	The system is disconnected from utility grid and runs as a stand-alone system.

#### NOTICE

If the device is in standby mode for more than 10 minutes, please check:

- Whether the insolation is sufficient and the PV connection is correct.
- Whether the battery level is sufficient and the cable connection is correct.
- If no anomaly is found, disconnect the DC switch and the main switch to restart.
- If it still does not work, contact SUNGROW.

## 10.2 LCD Menu

The following figure shows the LCD menu.

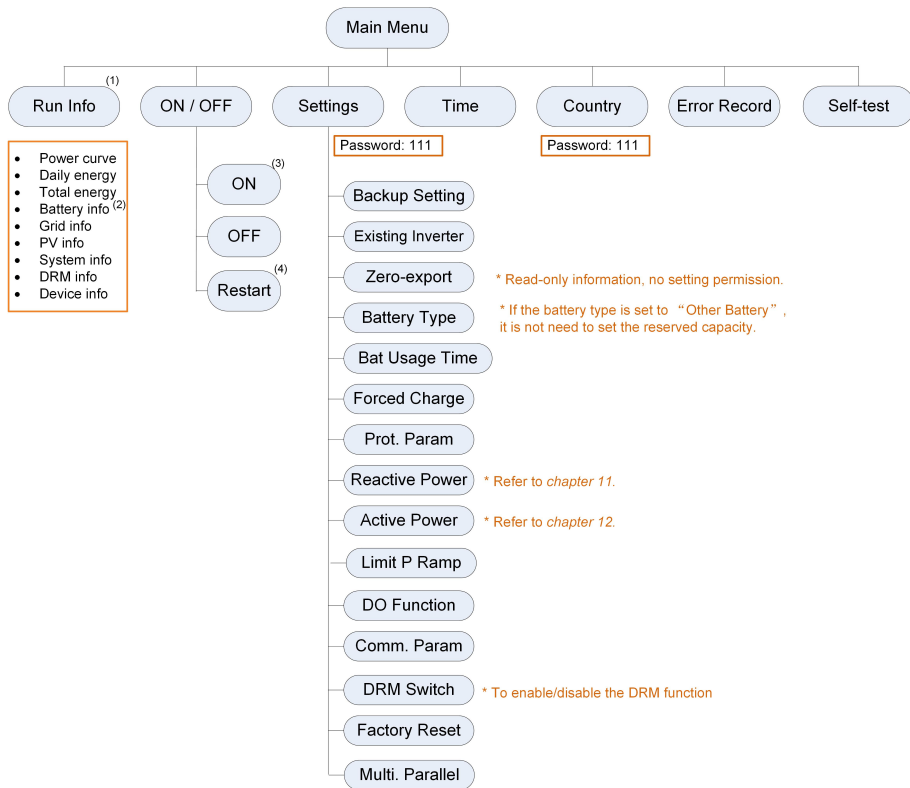

Figure 10-1 LCD Menu Tree

(1) The power value indicated represents the average value during the time interval. The energy yields displayed are indicative only. For the actual yields, please refer to the electric energy meter.

(2) The value of battery SOH will be displayed as " - " for GCL batteries that do not have this parameter. The SOC value for lead-acid batteries is for reference only.

(3) For Australia and New Zealand, the DRM0 state will prohibit the "ON".

(4) The "Restart" option will appear only if an unrecoverable fault occurs.

Table 10-2 Abbreviations

Abbreviation	Complete	Abbreviation	Complete
Csmp	Consumption	Tot	Total
Chrg	Charge	Tmp	Temperature
Bat	Battery	SOH	State of Health
SOC	State of Charge	Curr	Current
Vtg	Voltage	Inv	Inverter
Stt	State	Frq	Frequency



Abbreviation	Complete	Abbreviation	Complete
Pwr	Power	DRM	Demand respond mode
Cap	Capacity	Ref.	Reference
Ver.	Version	MDCV	Max. discharging current value
CSTVtgChrg	Constant charging voltage	MCCV	Max. charging current value
DChrg	Discharge	Multi.	Multiple
Prot.	Protection	DChrgEndVtg	Final discharge voltage
Comm.	Communication	En.	Enable

### 10.3 Starting and Stopping the Inverter

The "Restart" item will appear only if an unrecoverable fault occurs.

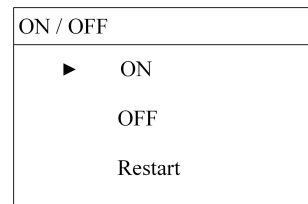

Confirm your choice by pressing **ENT**.

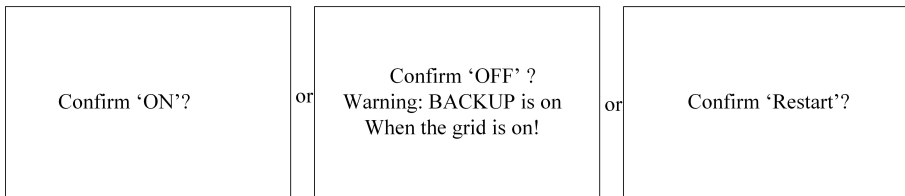

For Australia and New Zealand, when the DRM state is DRM0, the "ON" option will be prohibited.



## 10.4 Advanced Settings

### 10.4.1 Inputting Password

The parameter settings are protected with a password. If you want to set the inverter's parameters, you have to input the correct password.

Press **▲** to add the value and Press **ENT** to move the cursor to input the password **111**. Press **ENT** to confirm the password and enter the submenu.

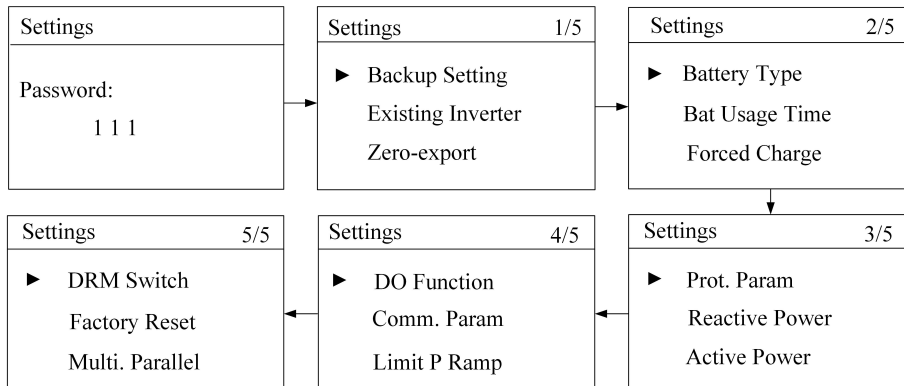

### 10.4.2 Setting Backup Function

The reserved capacity is the on-grid minimum battery discharge level. The reserved battery capacity will be supplied to the emergency loads in the off-grid system.

If the battery type is set to "Other Battery", it is not need to set the reserved capacity.

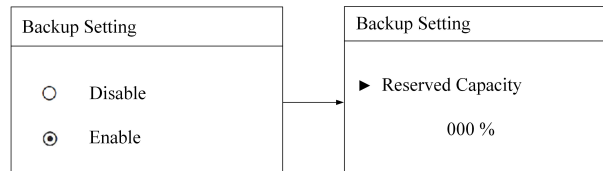

If the backup function is enabled, the buzzer inside the inverter will beep intermittently for 20 s when the battery level is lower than the threshold value specified in the following table.

Battery Type	SOC Threshold
Sungrow (retrofitting system)/ LG	≤ 6 %
BYD	≤ 11 %
GCL	≤ 16 %
Pylon (US2000B), TAWAKI	≤ 21 %
Lead-acid	≤ 45 V

### 10.4.3 Adding the Existing Inverter

Refer to the description in "7.4.2 Adding the Existing Inverter".

### 10.4.4 Setting Feed-in Power

Refer to the description in "7.4.3 Setting Feed-in Power".

### 10.4.5 Setting Battery Type

- 1 Refer to "10.3 Starting and Stopping the Inverter" to stop the inverter before modifying the battery type.

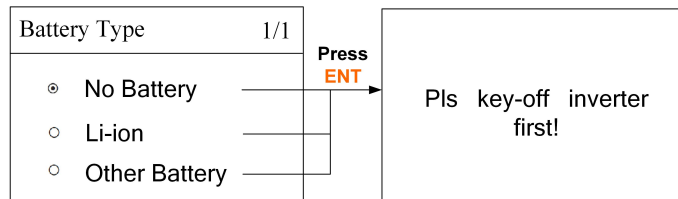

- 2 Press ▲/▼ to select and Press ENT to confirm. For lead-acid batteries, you should manually set the battery type.

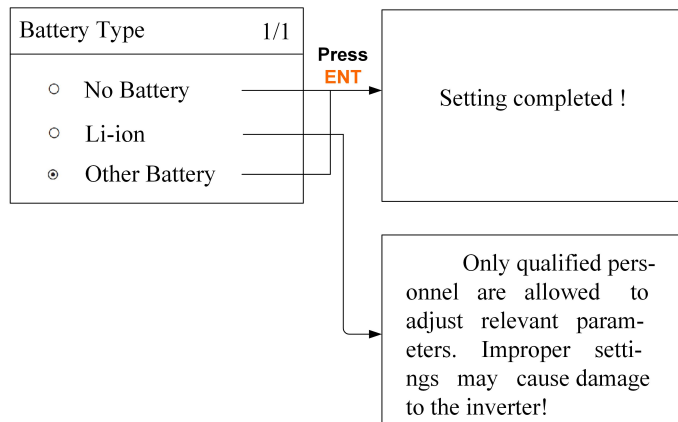

▶ Max. Chrg	0.300 C	▶ Over Vtg	58.8 V	▶ CSTVtgChrg	56.40 V
Max. DChrg	0.300 C	Low Vtg	42.0 V	DChrgEndVtg	43.20 V
Rated Vtg	048.0 V	Over Temp	60.0 °C		
Capacity	0200 Ah	Low Temp	-25.0 °C		

- Max. Chrg / Max. DChrg:
  - Make sure that the charge or discharge current is not beyond the upper limit (65 A) to protect the battery from overcharging or deep discharging.
  - The unit **C** is the "capacity", which refers to the maximum amount of charge that a battery can store. Refer to the manufacturer's specifications for details. If the max. charge or discharge is set to more than 65 A (e.g. C = 600 Ah, 0.3C = 180 A), then the inverter will limit the charge and discharge current to 65 A.

- The charge or discharge voltage is not beyond the upper limit (63 V / 70 V).
- Over Temp / Low Temp: If the battery voltage or temperature is beyond the allowable range, the related error codes will be triggered and the protection function will be activated to stop charging or discharging.
- DChrgEndVtg: Stop discharging at a voltage not lower than DChrgEndVtg, so as to protect the battery from deep discharging. The *DChrgEndVtg* setting value should be higher than the *Low Vtg* setting value.

Table 10-3 Parameter Description for Other Battery

Parameter	Description	Range
Max. Chrg	The upper limit of the charging current	0.05C to 2C
Max. DChrg	The upper limit of the discharging current	0.1C to 2C
Rate Vtg	The rated voltage of the equipped battery	30 V to 60 V
Capacity	Capacity of the battery tray	10 Ah to 1000 Ah
Over Vtg	The upper limit of battery voltage when charging	48 V to 70 V
Low Vtg	The lower limit of battery voltage when discharging	32 V to 48 V
Over Temp	The upper limit of battery temperature	20°C to 70°C
Low Temp	The lower limit of battery temperature	-30°C to 10°C
CSTVtgChar	The voltage of constant-voltage charging.	40 V to 63 V
DChrgEndVtg	The voltage at which the discharging is stopped	30 V to 53 V

**NOTICE**

The parameters can only be set by qualified personnel. Consult the battery manufacturer for an advice before any modification.

#### 10.4.6 Setting Battery Usage Time

When there is no battery equipped in the system, a prompt will appear. Press ENT to continue the setting.

No Battery !

Battery usage enabled (Weekday):

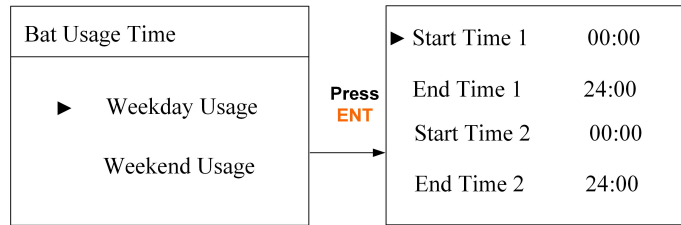

Battery usage enabled (Weekend):

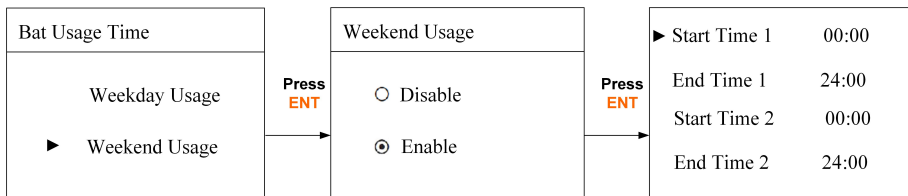

### 10.4.7 Setting Forced Charge

In the system without a battery, a prompt will appear. Press ENT to continue the setting.

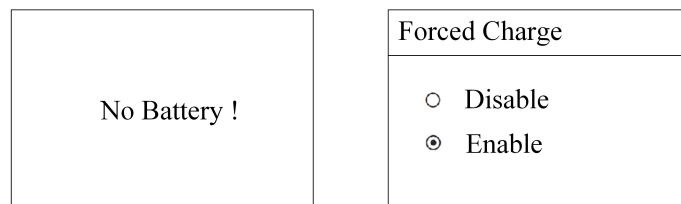

Forced Charge 1/3	Forced Charge 2/3	Forced Charge 3/3
Time [ Weekday ]	▶ Start time1 00:00 End time1 00:00 Target SOC 100%	▶ Start time2 00:00 End time2 00:00 Target SOC 100%

- When there is no PV power, the import power from the grid charges the energy system during the time period until the target SOC is reached.
- It is recommended to set the time period in off-peak tariff time. The time period 1 is in priority to the time period 2 if two periods overlap.
- The charging energy comes from the excess PV energy in priority to the energy from the grid. The inverter will sink the charging power from the grid in the case of PV energy shortage.

### 10.4.8 Setting the Protective Parameters

Protective parameters are designed for the threshold values that can trigger the protective function of the inverter. The threshold values are compliant with the requirements of local safety standards and the utility grid.

If the protection function is triggered, the inverter will automatically disconnect from the grid. In this case, the system can be automatically switched to off-grid running if the

backup function has been enabled via the LCD menu. Otherwise the inverter will stop running with the " Error " state displayed on the LCD main screen.

For more parameter settings, please visit the iSolarCloud App or the iSolarCloud server. For the function of interface protection system (SPI) for Italy, see "6.12.2 SPI Connection ("IT")".

▶ V <sub>max-recover</sub> 253.0 V <sub>min-recover</sub> 205.0V	▶ F <sub>max-recover</sub> 50.15Hz F <sub>min-recover</sub> 47.50Hz
---	--

After the grid voltage or frequency recovers to the specified range, the corresponding error code displayed on the LCD will be cleared and the inverter will resume on-grid running.

▶ Power Ramp Rate En. [ Enable ] Power Ramp Rate 016.67%	▶ 10 Min Over Vtg En. [ Enable ] 10 Min Over Vtg 255.0V
---	--

- **Power Ramp Rate:** the ramp up/down rate of power variation. The power rate limit mode is enabled by default. Set to *Disable* to turn off the function.
- **10 Min Over Vtg:** 10-minute overvoltage protection. The inverter will automatically disconnect from the grid within 3 s when the average voltage for a 10 min period exceeds the set-point of **10 Min Over Vtg**. Set to *Disable* to turn off the function.

Table 10-4 Recovery Parameter Explanation

Parameter	Explanation	Range
V <sub>max-recover</sub>	Recovery value for overvoltage fault. Inverter can start operating only when the grid voltage is below this value.	230.0 – 299.0 (V)
V <sub>min-recover</sub>	Recovery value for undervoltage fault. Inverter can start operating only when the grid voltage is above this value.	130.0 – 230.0 (V)
F <sub>max-recover</sub>	Recovery value for overfrequency fault. Inverter can start operating only when the grid frequency is below this value.	Not BRA: 50.00 – 55.00 (Hz) BRA: 60.00 – 65.00 (Hz)

Parameter	Explanation	Range
$F_{\min\text{-recover}}$	Recovery value for underfrequency fault. Inverter can start operating only when the grid frequency is above this value.	Not BRA: 45.00 – 50.00 (Hz) BRA: 55.00 – 60.00 (Hz)
Power Ramp Rate	The ramp rate of power variation.	5 – 100 (%)
10-min Over Vtg	Overvoltage protection value of 10-min average voltage	244.0 – 258.0 (V)

Table 10-5 Default Values of Protective Parameters (1) (AU)

Parameter Explanation	Default	AG	EE	EG	PN	PC	WP
$V_{\max\text{-recover}}$ (V)	253.0	258.0	258.0	258.0	258.0	258.0	258.0
$V_{\min\text{-recover}}$ (V)	205.0	202.0	182.0	182.0	182.0	182.0	182.0
$F_{\max\text{-recover}}$ (Hz)	50.15	51.98	51.98	51.98	51.98	51.98	51.48
$F_{\min\text{-recover}}$ (Hz)	47.50	48.02	47.02	47.02	47.02	47.02	47.02
Power Ramp Rate (%)	16.67	16.67	16.67	16.67	16.67	16.67	16.67
10-min Over Vtg (V)	255.0	255.0	255.0	257.0	255.0	255.0	258.0

Table 10-6 Default Values of Protective Parameters (2)

Parameter Explanation	LUX	IT	DE	NL	AT	BE
$V_{\max\text{-recover}}$ (V)	253.0	253.0	251.0	251.0	253.0	253.0
$V_{\min\text{-recover}}$ (V)	195.5	197.5	195.5	195.5	207.0	195.5
$F_{\max\text{-recover}}$ (Hz)	50.05	50.10	50.15	50.05	50.05	50.05
$F_{\min\text{-recover}}$ (Hz)	47.52	49.90	47.52	48.02	47.52	47.52
Power Ramp Rate (%)	10.00	16.67	10.00	10.00	10.00	10.00
10-min Over Vtg (V)	253.0	253.0	253.0	Not applicable	257.6	253.0

Table 10-7 Default Values of Protective Parameters (3)

Parameter Explanation	NZ	SA	BRA		TH	
			220 V Grid	240 V Grid	220 V Grid	230 V Grid
$V_{\max\text{-recover}}$ (V)	253.0	251.0	240.0	262.0	240.0	237.2
$V_{\min\text{-recover}}$ (V)	205.0	197.5	178.0	194.0	200.0	202.1
$F_{\max\text{-recover}}$ (Hz)	50.15	51.98	60.10	60.10	51.98	51.98
$F_{\min\text{-recover}}$ (Hz)	47.50	47.02	59.90	59.90	47.02	47.02
Power Ramp Rate (%)	16.67	10.00	20.00	20.00	10.00	10.00
10-min Over Vtg (V)	248.0	Not applica- ble	255.0	255.0	Not applicable	

\* The default value of  $F_{\min\text{-recover}}$  is 47.52 Hz for Great Britain ("GB").

#### 10.4.9 Setting Reactive Power Regulation

Refer to the description in "[11 Appendix II: Reactive Power Regulation](#)".

#### 10.4.10 Setting Active Power Response

Refer to the description in "[12 Appendix III: Active Power Response](#)".

#### 10.4.11 Setting Limit Power Ramp

The limit power ramp function is disabled by default.

*Enable:* when there is a change in the PV input power, the output power through the grid-connected point will change with a ramp, but not suddenly.

Limit P Ramp
<input type="radio"/> Disable <input type="radio"/> Enable

#### 10.4.12 Setting DO Function

##### Setting Load Control

After connecting the load to the DO terminals, a relay control signal will be transmitted. Users can flexibly set the control mode via the LCD menu. Press **▲/▼** to choose the control mode. Press **ENT** to confirm.

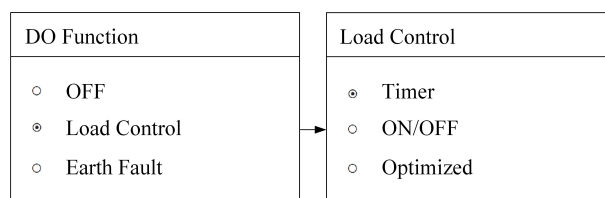

- Timer Control



In this mode, set the Start time and End time, the system will control the load operation during the interval. Take 09:00 am – 09:30 am as an example.

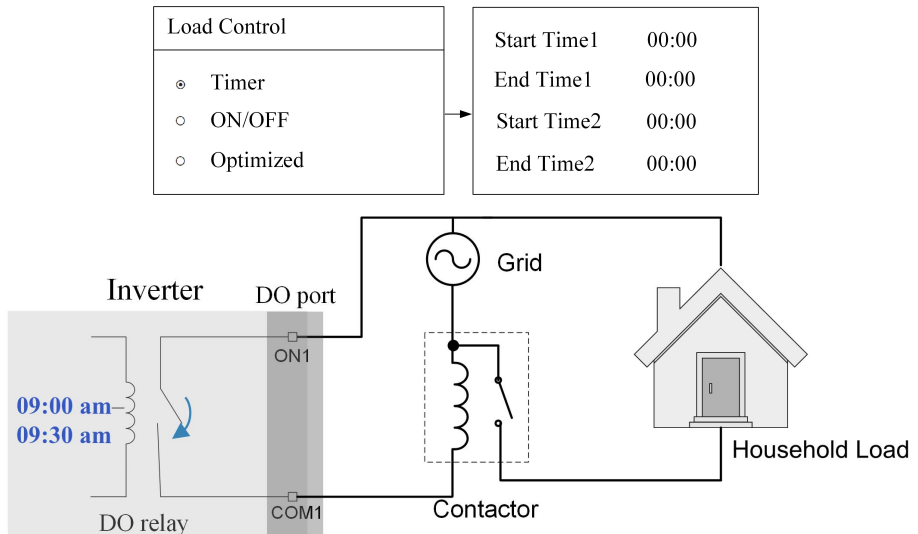

Figure 10-2 DO Operation in Timer Control

- ON/OFF Control

In this mode, the system will control the load operation according to the setting. Set to **OFF** in the following example.

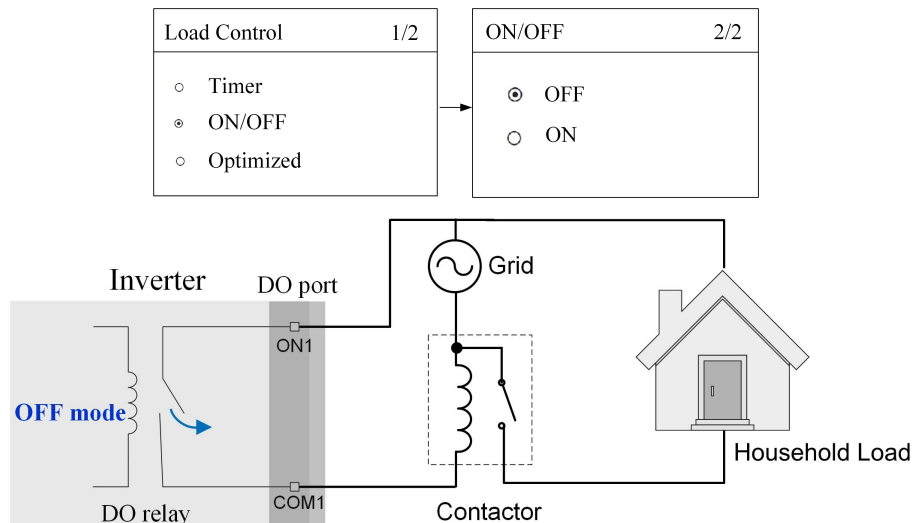

Figure 10-3 DO Operation in ON/OFF Control

- Optimized Control

The system will control the load operation according to the power optimization algorithm of energy management.

During the setting interval, the DO function will be enabled to power on the load if the excess PV energy exceeds the optimized power value.

Load Control	1/2	Optimized	P2/2
<ul style="list-style-type: none"> <li>○ Timer</li> <li>○ ON/OFF</li> <li>⊙ Optimized</li> </ul>		Start time	00:00
		End time	00:00
		Power[W]	1000

- The optimized mode is disabled in an off-grid system.
- When the existing system is enabled, the upper limit of optimized power is the sum of the rated power of the hybrid inverter and the rated power of the existing PV system.
- Once the optimized mode is enabled, the DO relay will not disconnect until 20 minutes after the DO connection.

Take 09:00 am – 09:30 am and the optimized power of 1000 W as an example.

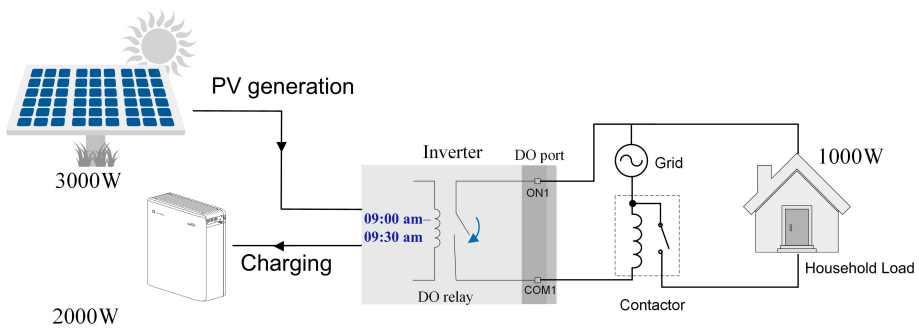

Figure 10-4 DO Operation in Optimized Control

### Testing Earth Fault

Test earth fault alarm and then automatically return to main menu after 3s.

Press ENT to confirm the earth fault alarm function. A prompt will appear.

DO Function	External earth fault alarm enabled! Press ENT to auto-test earth fault alarm !
<ul style="list-style-type: none"> <li>○ OFF</li> <li>○ Load Control</li> <li>⊙ Earth Fault</li> </ul>	

If you **press ENT** to go on the test, the DO relay will switch on automatically to signal the external alarm if a light indicator and/or buzzer is connected. The buzzer inside the inverter will beep. The PV insulation resistance fault (code 039) will trigger the DO relay to signal the external alarm.

Testing earth fault relay and buzzer inside alarm . . .

### 10.4.13 Setting the Communication Parameters

#### Ethernet

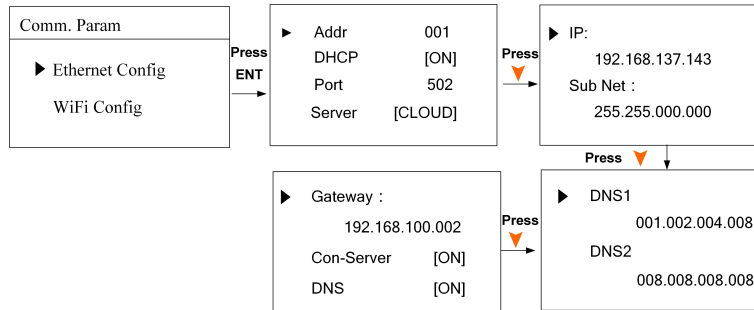

- The communication address ranges from 1 to 247.
- The IP, sub net, gateway, DNS1 and DNS2 can be modified only when the DHCP is set to OFF.
- Acquire the IP, subnet mask, gateway, DNS1 and DNS2 from the network professional.
- Set the Server to "CLOUD" if the data is uploaded to [www.isolarcloud.com](http://www.isolarcloud.com).

#### Wi-Fi

Quick Configuration: **Press ENT** to enable this function and then you can connect the inverter Wi-Fi to your home router quickly with the App.

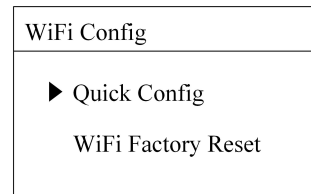

### 10.4.14 DRM Switch Setting

The DRM function to the DRED (demand response enabling device) is enabled by default. Set to *Disable* to turn off the function.

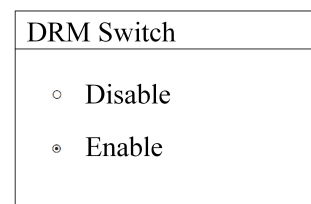

### 10.4.15 Factory Reset

#### NOTICE

All history information will be irrecoverably cleared and all parameters will return to the default values except the protection parameters and time once the "Factory Reset" is performed.

Firstly, set the inverter to "OFF" via the LCD menu.

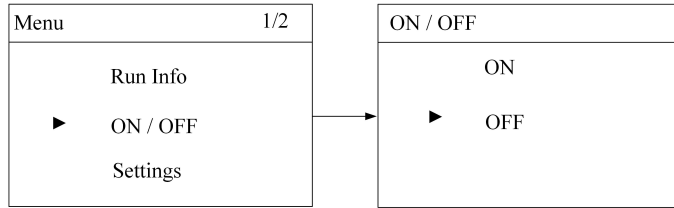

Enter the "Settings" menu and navigate to "Factory Reset". Press **ENT** to confirm.

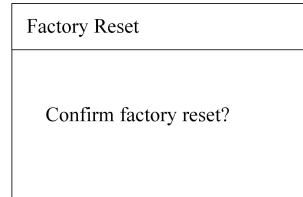

### 10.4.16 Multiple Parallel Setting

In a hybrid system with two inverters in parallel via an RS485 connection, enable the parallel setting.

Set the inverter directly connected to the Smart Energy Meter to **Master** and the other one to **Slave**.

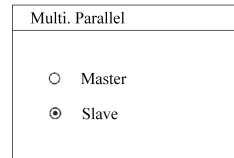
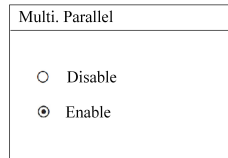

## 10.5 Setting System Time

Refer to the description in ["7.4.4 Setting System Time"](#).

## 10.6 Setting the Country

The country setting is protected with a password. Each country code represents corresponding local protective parameters that have been preset before delivery.

Press **▲** and Press **ENT** to input the password **111**.

Press **ENT** to confirm the password.

For the countries "AU", "NZ" and "BRA", you should set the grid standard according to the description in ["7.4.1 Setting the Country"](#).

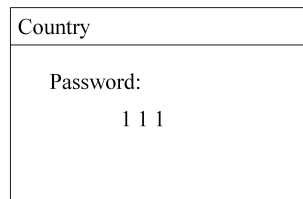

Table 10-8 Descriptions of the Country Codes

Country Code	Full Name	Language
GB	Great Britain	English
DE	Germany	German
FR	France	French

Country Code	Full Name	Language
IT	Italy	Italian
ES	Spain	English
AT	Austria	German
AU	Australia	English
CZ	Czech	English
BE	Belgium	French
DK	Denmark	English
GR_L	Greece Land	English
GR_IS	Greece Island	English
NL	Netherlands	Dutch
LUX	Luxembourg	Dutch
PT	Portugal	English
CN	China	Chinese
SE	Sweden	English
US	America	English
SA	South Africa	English
NZ	New Zealand	English
TH	Thailand	English
Other	Countries not included above	English

Table 10-9 Description of Multi-Stage Protective Parameters

Parameter	Explanation	Range
<b>Overvoltage</b>	Overvoltage protection	
1- $V_{max}$ (V)	Grid overvoltage 1 ( $V>$ )	230 V – 299 V
1-Time (s)	Grid overvoltage 1 ( $V>$ ) tripping time	0 – 600 s
1- $V_{max}$ (V)	Grid overvoltage 2 ( $V>>$ )	230 V – 311 V
2-Time (s)	Grid overvoltage 2 ( $V>>$ ) tripping time	0 – 600 s
<b>Undervoltage</b>	Undervoltage protection	
1- $V_{min}$ (V)	Grid undervoltage 1 ( $V<$ )	23 V – 230 V
1-Time (s)	Grid undervoltage 1 ( $V<$ ) tripping time	0 – 600 s
1- $V_{min}$ (V)	Grid undervoltage 2 ( $V<<$ )	23 V – 230 V
2-Time (s)	Grid undervoltage 2 ( $V<<$ ) tripping time	0 – 600 s
<b>Overfrequency</b>	Overfrequency protection	
1- $F_{max}$ (V)	Grid overfrequency 1 ( $F>$ )	50.00 Hz – 55.00 Hz
1-Time (s)	Grid overfrequency 1 ( $F>$ ) tripping time	0 – 600 s



Parameter	Explanation	Range
1-F <sub>max</sub> (V)	Grid overfrequency 2 (F>>)	50.00 Hz – 55.00 Hz
2-Time (s)	Grid overfrequency 2 (F>>) tripping time	0 – 600 s
<b>Underfrequency</b> Underfrequency protection		
1-F <sub>min</sub> (V)	Grid underfrequency 1 (F<)	45.00 Hz – 50.00 Hz
1-Time (s)	Grid underfrequency 1 (F<) tripping time	0 – 600 s
1-F <sub>min</sub> (V)	Grid underfrequency 2 (F<<)	45.00 Hz – 50.00 Hz
2-Time (s)	Grid underfrequency 2 (F<<) tripping time	0 – 600 s

**NOTICE**

In the off-grid parallel system, refer to 10.3 Starting and Stopping the Inverter to stop the inverter before modifying country or grid setting.

## 10.7 Viewing the Error Codes

### 10.7.1 Viewing Active Error

For the  icon or the "Error" state on the main screen, **press**  to view the current faults. Refer to "9.1.2 Troubleshooting of the Errors" for error description and troubleshooting.

Error Active	P1/I
001 GRID	008

Code  
Type

Refer to the following table for error type explanations.

Error Type	Explanation
GRID	Grid faults (AC side)
PV	PV faults (DC side)
SYS	System errors (inverter)
PER	Permanent faults
WARN	Warnings
BDCF	Faults of battery charge/discharge circuit
BDCPF	Permanent faults of battery charge/discharge circuit
BATW	Battery warnings
BATP	Battery protection
BATF1	Battery faults
BATF2	

### 10.7.2 Viewing Error Record

Press ▲/▼ to turn pages and view all error records.

1: the error is triggered.

0: the error is cleared.

Error Record	P1/20	
18110309:30:37	010	0
18110309:30:37	010	1
18110217:23:30	703	1
18110217:23:21	010	1
18110217:23:21	514	0

### 10.8 Self-test (Italy)

The inverter is integrated with interface protection functions and provides an auto test system to verify the maximum/minimum frequency and maximum/minimum voltage functions. The "Self-test" item can only display when the country code is set to "IT" (-Italy), so the screenshots introduced in this section will be in Italian.

Press ENT to confirm "Self-test" and start the auto test.

Menu	3/3	Self-test
▶ Self-test		▶ Self-test
		Clr. Test Fault

If the inverter is in the status of "Error" or "Turn off", it cannot start the test and a prompt interface will appear.

Cannot start in the case of fault and key-stop states!

During normal auto testing, the grid protection testing items will automatically go in the order as follows.

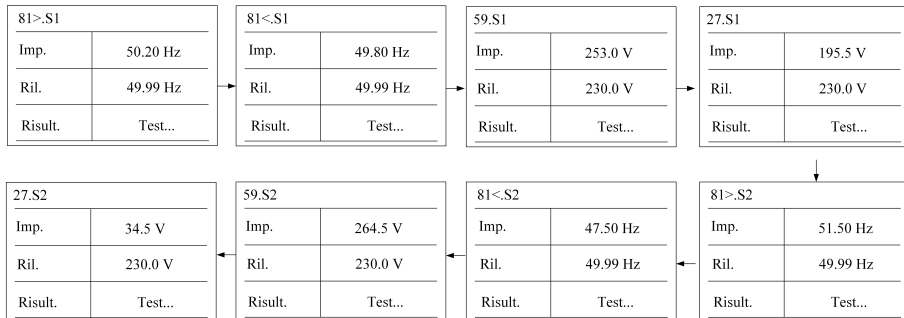

**Table 10-10** Operational Voltage Parameter Description

Parameter	Explanation
81>.S1	Overfrequency test (stage I)
81<.S1	Underfrequency test (stage I)
59.S1	Overvoltage test (stage I)
27.S1	Undervoltage test (stage I)
81>.S2	Overfrequency test (stage II)
81<.S2	Underfrequency test (stage II)
59.S2	Overvoltage test (stage II)
27.S2	Undervoltage test (stage II)
Imp.	The default protection threshold
Ril.	The actual sample value

- For over frequency/voltage protection testing, the default protection threshold (*Imp.*) is linearly decreased with a ramp  $\leq 0.05$  Hz/s or  $\leq 0.05$  Vn/s. The protection function will be triggered if the threshold is lower than the actual sample value (*Ril.*).
- For under frequency/voltage protection testing, the default protection threshold (*Imp.*) is linearly increased with a ramp  $\leq 0.05$  Hz/s or  $\leq 0.05$  Vn/s. The protection function will be triggered if the threshold is higher than the actual sample value (*Ril.*).

If the protection function is triggered, the LED indicator will be lit red and the corresponding error code will be displayed on the main screen. When the test is completed, the interface as shown will appear.

**Press** ▼ to view the test result and the trip time.

Completa!	
Imp.	0.0 V
Ril.	0.0 V
Risult.	Pass.

#### NOTICE

**Do not press ESC to exit this interface, otherwise the test results will be cleared and you need to do the test again.**

For each test, the values of frequency/voltage and the trip times will be visualized as well as the current values of the frequency and voltage measured by the inverter. **Press** ▲/▼ to scroll pages and **press** ESC to exit.

The thresholds (*Imp.*) are compliant with standard CEI 0-21 and the actual values (*Ril.*) are for your reference only.



**Pass.:** The inverter will restore the normally used settings and automatically reconnect to the grid.

**Fail:** The inverter will report the error **105**. The inverter cannot reconnect to the network until the test faults are cleared.

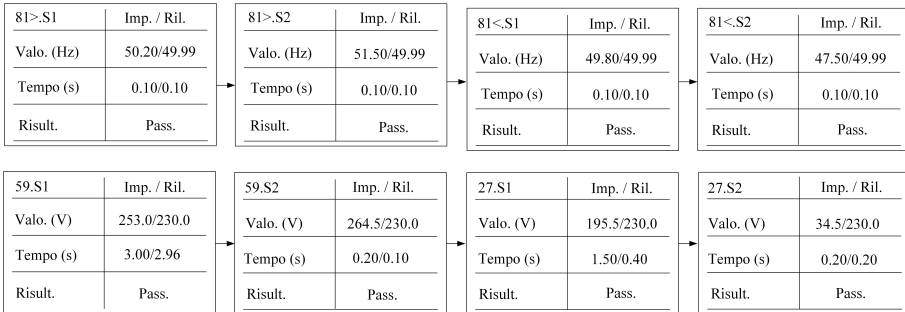

If the auto test fails, **Press ENT** to confirm "Canc. Guasto Test" and clear the test faults.

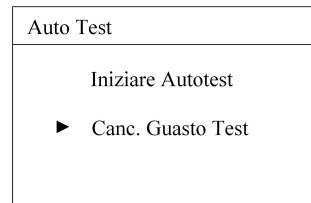

**NOTICE**

If an external command aimed at changing the frequency protection thresholds is sent to the inverter during the testing process, the test results will be invalid. You should restart the system and re-do the auto test.

# 11 Appendix II: Reactive Power Regulation

The submenu is as shown on the right.

Refer to "10.2 LCD Menu" for the navigation.

Press ▲/▼ to select the desired option and Press ENT to confirm.

**OFF:** The reactive power regulation function is disabled. The power factor (PF) is limited to +1.000.

Reactive Power	
<input checked="" type="radio"/> OFF	<input type="radio"/> PF
<input type="radio"/> Qt	<input type="radio"/> Q(P)
<input type="radio"/> Q(U)	

## 11.1 "PF" mode

The inverter is capable of operating with fixed power factor. The PF ranges from 0.8 leading to 0.8 lagging.

Reactive Power	PF Setting
<input type="radio"/> OFF <input checked="" type="radio"/> PF <input type="radio"/> Qt <input type="radio"/> Q(P) <input type="radio"/> Q(U)	▶ PF      + 1.000 + : Laggingg & - : Leading

- **Leading:** the inverter is sourcing reactive power to the grid.
- **Lagging:** the inverter is sinking reactive power from the grid.

## 11.2 "Qt" mode

**Qt limit:** the maximum ratio of reactive power to rated apparent power in %.

The Qt limit ranges from -60.0 % to +60.0 %.

Qt Setting
▶ Qt Limit      + 000.0%

## 11.3 "Q(P)" Mode

The Q (P) parameter setting via LCD menu is only available for countries "IT", "TH", "BRA", "AU" and "NZ". For other countries, please set the Q (P) parameters via the iSolarCloud App or the iSolarCloud server.

### 11.3.1 For Countries "IT" and "TH"

The PF of the inverter output varies in response to the output power of the inverter.

▶ PA	020.0%	▶ U <sub>in</sub>	105.0%
PB	050.0%	U <sub>out</sub>	100.0%
PC	100.0%		
PF Max	0.950		

Table 11-1 "Q(P)" Mode Parameters Explanation ("IT", "TH")

Parameter	Explanation	Default	Range
PA	Active power at point A (in %)	20 %	20 % – 100 %
PB	Active power at point B (in %)	50 %	20 % – 100 %
PC	Active power at point C (in %)	100 %	20 % – 100 %
PF Max	Power factor at point C	0.95	0.90 – 1
U <sub>in</sub>	Enter into the Q(P) regulation mode when the grid voltage is above U <sub>in</sub>	105 %	100 % – 110 %
U <sub>out</sub>	Exit from the Q(P) regulation mode when the grid voltage is below U <sub>out</sub>	100 %	90 % – 100 %

\* PA < PB ≤ PC, U<sub>in</sub> > U<sub>out</sub>

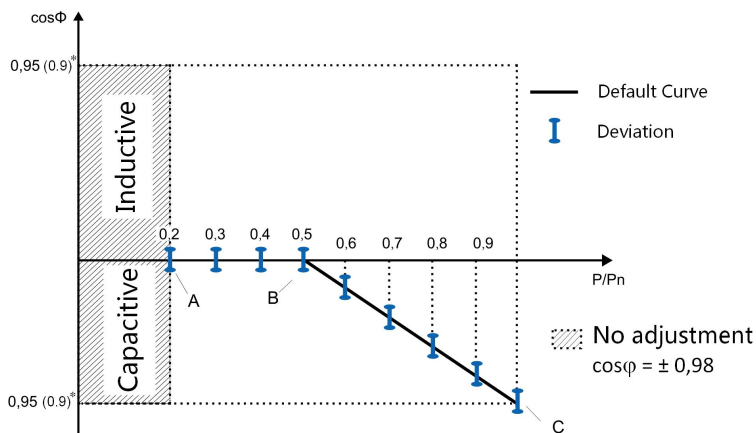

Figure 11-1 Reactive Power Regulation Curve in Q(P) Mode ("IT" for example)

\* The maximum PF depends on the total rated power of the system. The max. PF is 0.95 by default for a system not greater than 11.08 kW. Set it to 0.9 if the system capacity is beyond 11.08 kW.

### 11.3.2 For Countries except "IT" and "TH"

The PF of the inverter output varies in response to the output power of the inverter. The parameters  $U_{in}$  and  $U_{out}$  are only applicable to the country "BRA".

Leading PF	1.000	$U_{in}$	104.0%
Lagging PF	0.900	$U_{out}$	100.0%
Upper Power	100.0%		
Lower Power	50.0%		

Table 11-2 "Q(P)" Mode Parameters Explanation

Parameter	Explanation	Default		Range
		AU, NZ, AT, NL, BE, LUX	DE, BRA, SA	
Leading PF	Power factor of the lower power point	1.000	1.000	0.900 – 1.000
Lagging PF	Power factor of the upper power point	0.900	0.950	0.900 – 1.000
Lower Power*	Lower limit of the output power (in %)	50.0 %	50.0 %	0 – 50.0 %
Upper Power*	Upper limit of the output power (in %)	100.0 %	100.0 %	50.0 % – 100.0 %
$U_{in}$	Enter into the Q(P) regulation mode when the grid voltage is above $U_{in}$	/	104.0 % (BRA)	100.0 % – 110.0 %
$U_{out}$	Exit from the Q(P) regulation mode when the grid voltage is below $U_{out}$	/	100.0 % (BRA)	90.0 % – 100.0 %

\* Lower Power < Upper Power

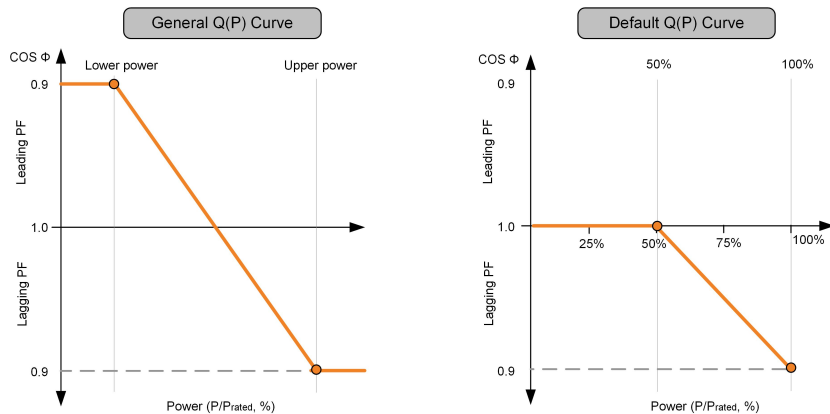

Figure 11-2 Reactive Power Regulation Curve in Q(P) Mode ("AU" for example

### 11.4 "Q(U)" Mode

The Q (U) mode is not applicable to countries "BRA" and "SA". The Q (U) parameter setting via LCD menu is only available for countries "AU" and "NZ". Set the Q (U) parameters via the iSolarCloud App or the iSolarCloud server for other countries.

#### 11.4.1 For Countries "IT" and "TH"

Table 11-3 Italy "Q(U)" Mode Parameters Explanation

Parameter	Explanation	Default	Range
V2i*	Grid voltage at point A (in %)	90 %	90 % – 110 %
V1i*	Grid voltage at point B (in %)	92 %	90 % – 110 %
V1s*	Grid voltage at point C (in %)	108 %	90 % – 110 %
V2s*	Grid voltage at point D (in %)	110 %	90 % – 110 %
k	The ratio of the base reactive power (in %)	10 %	0 – 100 %
Pin**	Enter into the Q(U) regulation mode when the power is above Pin	20 %	20 % – 100 %
Pout**	Exit from the Q(U) regulation mode when the power is below Pout	5 %	1 % – 20 %
Qmax	The max. ratio of reactive power (in %)	32.8 %	0 – 60 %

\* V2i < V1i < V1s < V2s, \*\* Pin > Pout

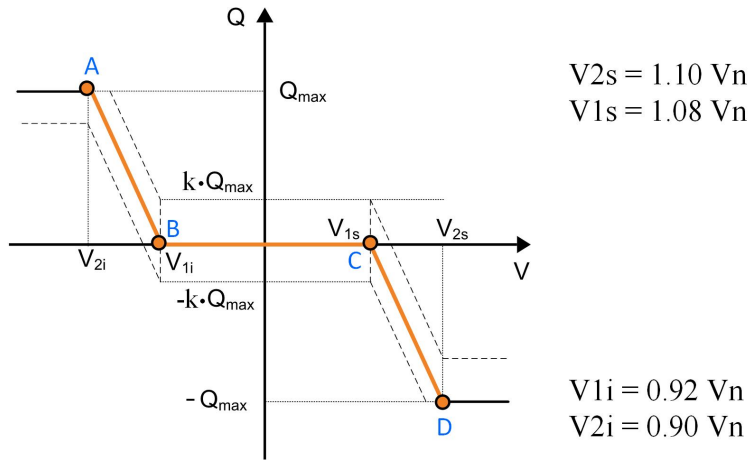

Figure 11-3 Reactive Power Regulation Curve in "IT" Q(U) Mode

### 11.4.2 For Countries except "IT" and "TH"

Define the response curve with four grid voltages. The reactive power output of the inverter will vary in response to the grid voltage.

<ul style="list-style-type: none"> <li>▶ V1 Ref. 207.0V</li> <li>▶ V2 Ref. 220.0V</li> <li>▶ V3 Ref. 250.0V</li> <li>▶ V4 Ref. 265.0V</li> </ul>	→	<ul style="list-style-type: none"> <li>▶ Q1 Ref. +030.0%</li> <li>▶ Q2 Ref. +000.0%</li> <li>▶ Q3 Ref. +000.0%</li> <li>▶ Q4 Ref. -030.0%</li> </ul>
--	---	--

Table 11-4 "Q(U)" Mode Parameter Explanations (AU, NZ)

Parameter	Explanation	Default			Range
		AU (WP)	AU (- except WP)	NZ	
V1 Ref.	Grid voltage reference value 1	205.0 V	207.0 V	207.0 V	
V2 Ref.	Grid voltage reference value 2	220.0 V	220.0 V	220.0 V	46 V – 299 V
V3 Ref.	Grid voltage reference value 3	235.0 V	250.0 V	244.0 V	
V4 Ref.	Grid voltage reference value 4	250.0 V	265.0 V	255.0 V	
Q1 Ref.	Reactive power at voltage V1	+030.0 %	+030.0 %	+030.0 %	-100.0 % –
Q2 Ref.	Reactive power at voltage V1	+000.0 %	+000.0 %	+000.0 %	+100.0 %

Parameter	Explanation	Default			Range
		AU (WP)	AU (- except WP)	NZ	
Q3 Ref.	Reactive power at voltage V2	+000.0 %	+000.0 %	+000.0 %	
Q4 Ref.	Reactive power at voltage V3	-030.0 %	-030.0 %	-030.0 %	

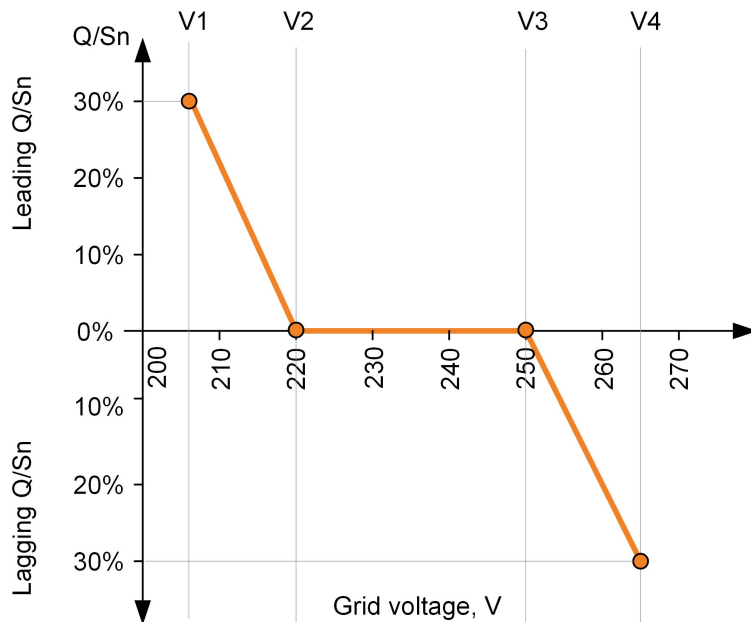

Figure 11-4 Reactive Power Regulation Curve in Q(U) Curve ("AU" for example)

Table 11-5 "Q(U)" Mode Parameter Explanations (DE, BE, LUX, NL)

Parameter	Range	Default		
		DE	NL, BE, LUX,	Other
V1 Ref.	80 % - 94 %	93 %	90 %	80 %
V2 Ref.	95 % - 100 %	97 %	92 %	95 %
V3 Ref.	100 % - 105 %	103 %	108 %	105 %
V4 Ref.	106 % - 120 %	107 %	110 %	115 %
Q1 Ref.	0 - 60 %	60 %	60 %	30 %
Q2 Ref.	-100.0 % to +100.0 %	+000.0 %	+000.0 %	+000.0 %
Q3 Ref.	-100.0 % to +100.0 %	+000.0 %	+000.0 %	+000.0 %
Q4 Ref.	0 - 60 %	60 %	60 %	30 %
Hysteresis *	0 - 5 %	0 %	0 %	3 %

\* Hysteresis voltage width (in %), V2 Ref. + Hysteresis < V3 Ref. Hysteresis

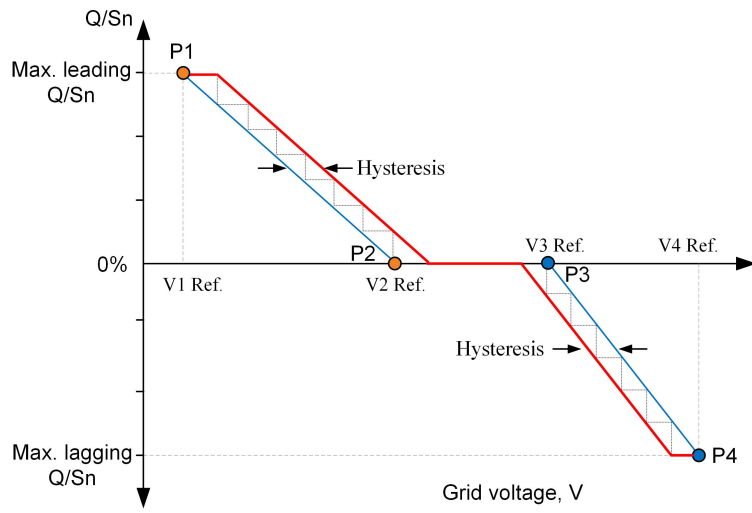

Figure 11-5 Reactive Power Regulation Curve in Q(U) Curve ("DE" for example)



## 12 Appendix III: Active Power Response

The submenu is as shown on the right.

Refer to "10.2 LCD Menu" for the navigation.

Press ▲/▼ to select the desired option and Press ENT to confirm.

Active Power
▶ Volt-watt
Frq-watt
Volt-watt (Chrg)

### 12.1 Volt-watt Response

Only countries "IT", "AU", "NZ" support this response mode.

#### 12.1.1 For the Country "IT"

The active power reduction function for voltage values is disabled by default. If the function is enabled, the active power output will be reduced when the grid voltage stated on the LCD screen has a value higher than 112 %  $V_n$  (nominal voltage). The charge power drawn from the grid will be at least equal to 80 % \*  $P_{cmax}$ , within 5 minutes, where the  $P_{cmax}$  is the maximum charge power of the system.

When the grid voltage falls lower than 108 %  $V_n$ , the inverter will response and the active power output will return then to the values consistent with the power available by the DC side.

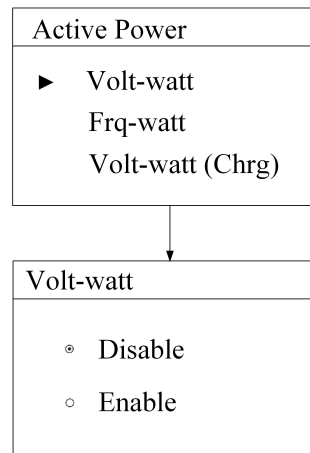

#### 12.1.2 For Countries "AU" and "NZ"

The Volt-watt response mode is enabled by default. Set four grid voltage reference values. The output power of the inverter will vary in response to the grid voltages.

Volt-watt	1/2	▶ V1 Ref. 207.0V	▶ P1 Ref. 100.0%
◦ Disable		V2 Ref. 220.0V	P2 Ref. 100.0%
◦ Enable		V3 Ref. 250.0V	P3 Ref. 100.0%
		V4 Ref. 265.0V	P4 Ref. 020.0%

Table 12-1 "Volt-Watt" Mode Parameter Explanations

Parameter	Explanation	Default (AU)	Default (NZ)	Range
V1 Ref.	Grid voltage reference value 1	207.0 V	207.0 V	46 V – 299 V
V2 Ref.	Grid voltage reference value 2	220.0 V	220.0 V	
V3 Ref.	Grid voltage reference value 3	250.0 V	244.0 V	
V4 Ref.	Grid voltage reference value 4	265.0 V	255.0 V	
P1 Ref.	Active power at voltage V1	100.0 %	100.0 %	000.0 % – 100.0 %
P2 Ref.	Active power at voltage V2	100.0 %	100.0 %	
P3 Ref.	Active power at voltage V3	100.0 %	100.0 %	
P4 Ref.	Active power at voltage V4	020.0 %	020.0 %	

The response curve is defined by the voltage reference values and corresponding power levels.

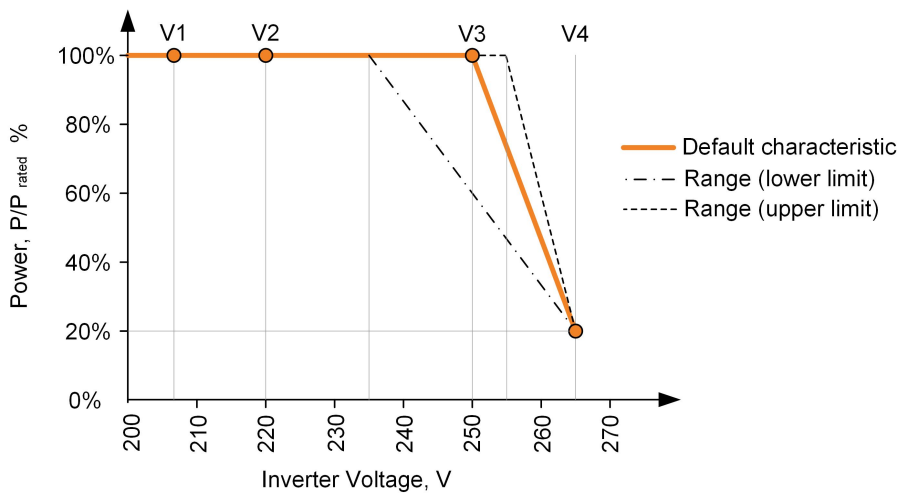

Figure 12-1 Volt-Watt Response Curve ("AU" for example)

## 12.2 Frq-Watt Response

All countries support the overfrequency response, but only countries "AU" and "NZ" support the under-frequency response.

Table 12-2 Description of Frq-watt Parameters

Parameter	Description
OverFrq Start	The Start frequency value for overfrequency response.
OverFrq End	The Stop frequency value for overfrequency response.
UnderFrq Start	The Start frequency value for underfrequency response.
UnderFrq End	The Stop frequency value for underfrequency response.
Frq Adj. Delay	The time delay for frequency adjusting. Only for Italy.

### 12.2.1 For the Country "IT"

Press ▼ to select *Frq-watt* and Press ENT to confirm.

Active Power
Volt-watt
▶ Frq-watt
Volt-watt (Chrg)

The variation of the active power generated by the system will take place for exceeding of the threshold values in the overfrequency adjustable between 50 and 52 Hz (default of 50.20 Hz).

▶ OverFrq Start	50.20 Hz
OverFrq End	51.50 Hz

The variation of the active power absorbed by the system will take place for exceeding of the threshold values in the underfrequency adjustable between 47 and 50 Hz (default of 49.80 Hz).

▶ UnderFrq Start	49.80 Hz
UnderFrq End	49.10 Hz

The power control of function active for transient over/under frequency has an activation delay can be set from 0 to 1 s with 50 ms steps (default of 0.20 s).

▶ Frq Adj. Delay	0.20 s
------------------	--------

The quadrilateral in the following figure shows the active power control in the conditions of over/under frequency. The area included in the central rectangular zone defines the possible points of normal operation in which the storage system may be at work and from these points the system will have to change its active power and move to the vertices of the quadrilateral according to the thresholds of over/under frequency (see dashed lines).

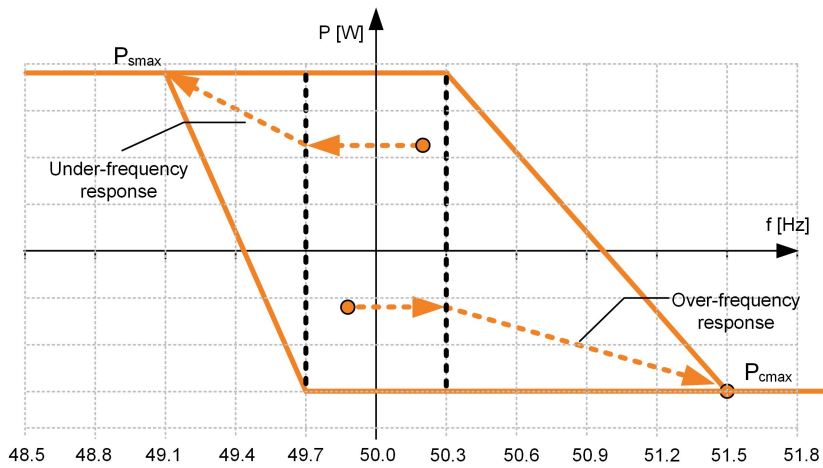

Figure 12-2 Control of Active Power in Conditions of Over/Under frequency

\*  $P_{smax}$ : the maximum discharge power;  $P_{cmax}$ : the maximum charge power

When the grid frequency returns back to  $50 \pm 0.1$  Hz (default setting) for a minimum continuous time of 300 s, the system will end the frequency response and return to its ordinary operation linearly with a transitional time not less than 300 s, as shown in the figure below.

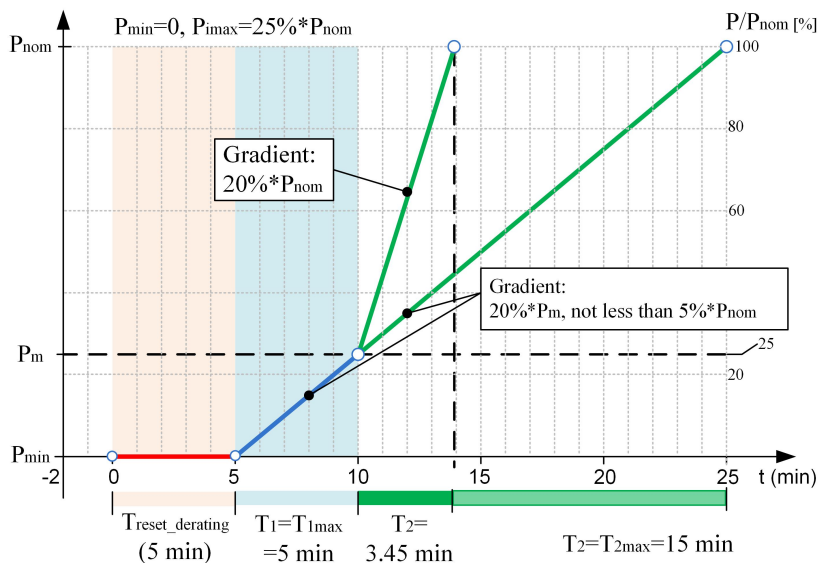

Figure 12-3 Power Restoration in Condition of Transient Overfrequency

- $P_m$ : active power delivered instantly exceeded 50.3 Hz (setting value)
- $P_{nom}$ : nominal power of the hybrid inverter
- $P_{min}$ : minimum power obtained during the transient overfrequency

### 12.2.2 For Countries except "IT"

#### Response to an increase in grid frequency

All countries support the overfrequency response.

When there is an increase in grid frequency which exceeds the Start value (50.25 Hz), the inverter will reduce the power output linearly with an increase of frequency until the End value (52.00 Hz) is reached.

When the frequency exceeds the End value, the inverter output shall be ceased (i.e. 0 W).

► OverFrq Start	50.25 Hz
OverFrq End	52.00 Hz

Table 12-3 Default Values of Overfrequency Response Parameters

Parameter	AU, NZ	BRA	TH	SA	AT, DE, NL, BE, LUX
OverFrq Start (Hz)	50.25	60.50	51.00	50.50	50.20
OverFrq End (Hz)	52.00	62.00	52.00	52.00	51.50

Take Australia ("AU") as an example. The output power will remain at or below the lowest power level reached in response to an overfrequency event between 50.25 Hz and 52 Hz. This is to provide hysteresis in the control of the inverter. When the grid frequency has decreased back to 50.15 Hz or less for at least 60 s, the power level will be increased at a rate no greater than the power ramp rate limit, which can be set according to "10.4.8 Setting the Protective Parameters".

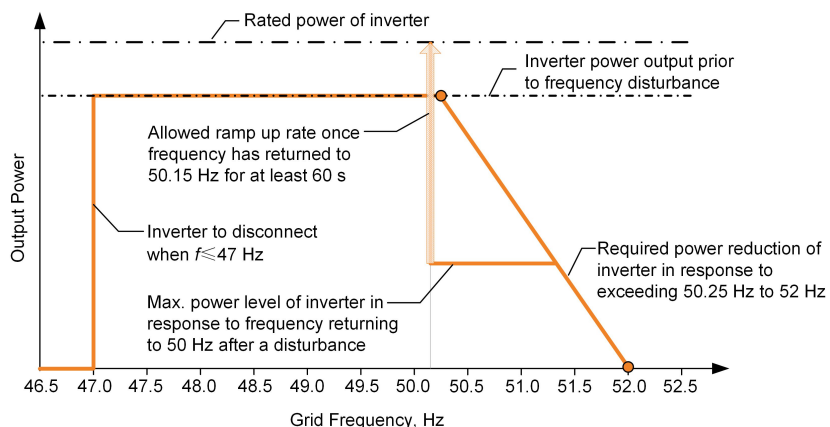

Figure 12-4 Frq-Watt Mode for Overfrequency Conditions ("AU")

#### Response to a decrease in grid frequency

Only countries "AU" and "NZ" support the underfrequency response.

When there is a decrease in grid frequency which falls below the Start value (49.75 Hz by default), the inverter will reduce the sinking power from the grid linearly with a decrease of frequency until the End value (49.00 Hz by default) is reached.

► UnderFrq Start	49.75 Hz
UnderFrq End	49.00 Hz

When the frequency falls below the End value, the inverter should have ceased sinking power from the grid (i.e. 0 W).

The import power for charging the storage system will remain at or below the lowest charge rate reached in response to a low-frequency event between 49 Hz and 49.75 Hz. This is to provide hysteresis in the control of the inverter.

When the grid frequency has increased back to 49.85 Hz or more for at least 60 s, the charge rate of the storage system may be increased at a rate no greater than the power ramp rate limit, which can be set according to "10.4.8 Setting the Protective Parameters".

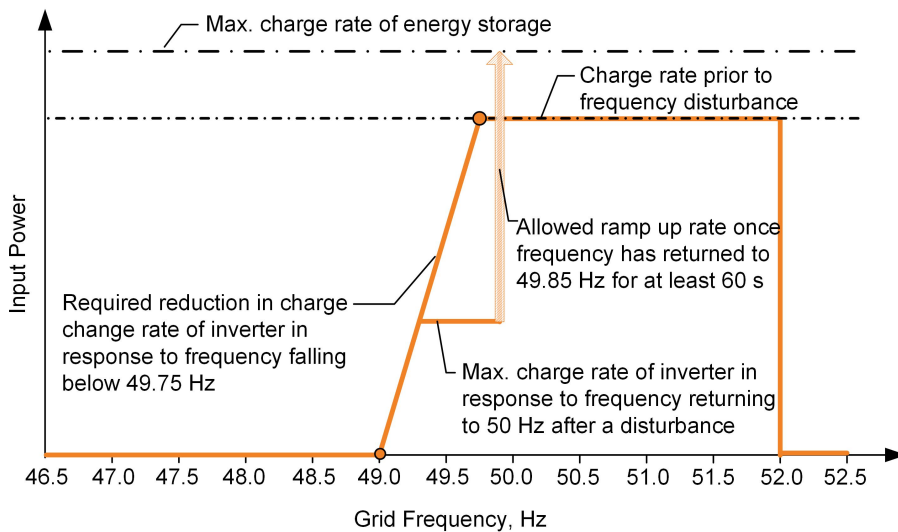

Figure 12-5 Frq-Watt Mode for Underfrequency Conditions ("AU")

### 12.3 Volt-watt Response (Charging)

Only countries "AU" and "NZ" support this response mode.

When the power from the grid is required to charge the energy storage system, the import power from the grid varies in response to the grid voltages. The response curve is defined by the voltage reference values and the corresponding power consumption from the grid for charging energy storage.

The Volt-watt response mode for battery charging is enabled by default.

Set four grid voltages and the corresponding power consumption upper limits (in % to the maximum input power 3000 W).

Volt-watt (Chrg)	1/2
<ul style="list-style-type: none"> <li><input type="radio"/> Disable</li> <li><input checked="" type="radio"/> Enable</li> </ul>	

The output power of the inverter will vary in response to the grid voltages.

▶ V1 Ref.	207.0V
V2 Ref.	220.0V
V3 Ref.	250.0V
V4 Ref.	265.0V

▶ P1 Ref.	0.0%
P2 Ref.	100.0%
P3 Ref.	100.0%
P4 Ref.	100.0%

Table 12-4 "Volt-Watt (Chrg)" Mode Parameter Explanations

Parameter	Explanation	Default AU (WP)	Default AU (not WP)	Default (NZ)	Range
V1 Ref.	Grid voltage reference value 1	205.0 V	207.0 V	207.0 V	190 V – 215 V
V2 Ref.	Grid voltage reference value 2	220.0 V	220.0 V	220.0 V	216 V – 230 V
V3 Ref.	Grid voltage reference value 3	235.0 V	250.0 V	244.0 V	235 V – 255 V
V4 Ref.	Grid voltage reference value 4	250.0 V	265.0 V	255.0 V	244 V – 265 V
P1 Ref.	Active power at voltage V1	0.0 %	0.0 %	0.0 %	
P2 Ref.	Active power at voltage V2	100.0 %	100.0 %	100.0 %	0.0 % –
P3 Ref.	Active power at voltage V3	100.0 %	100.0 %	100.0 %	100.0 %
P4 Ref.	Active power at voltage V4	100.0 %	100.0 %	100.0 %	

The response curve is defined by the voltage reference values and corresponding power levels.

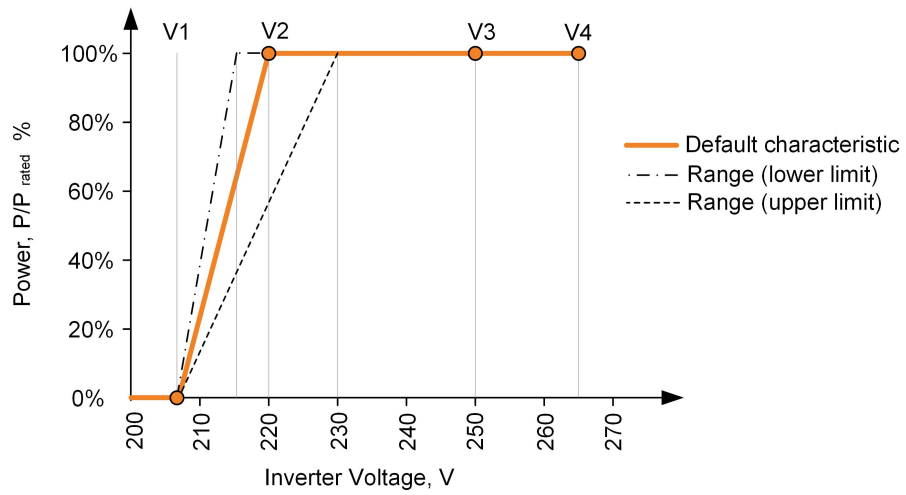

Figure 12-6 Vtg-Watt Response Mode for Battery Charging Curve ("AU" for example)



## 13 Appendix IV: Technical Data

### 13.1 Inverter

Parameters	SH3K6-30	SH4K6-30	SH5K-30
<b>Input (DC)</b>			
Max. PV input power	6600 W		
Max. PV input voltage	600 V		
Startup voltage	125 V		
Nominal input voltage	350 V		
MPP voltage range	125 V – 560 V		
MPP voltage range for nominal power	180 V – 520 V	220 V – 520 V	240 V – 520 V
No. of MPPTs	2		
Max. number of PV strings per MPPT	1 / 1		
Max. PV input current	11 A / 11 A		
Max. current for input connector	12 A / 12 A		
Max. DC Short-circuit current	12 A / 12 A		
Max. inverter backfeed current to strings	0 A		
<b>Battery</b>			
Battery type	Li-ion battery / Lead-acid battery		
Battery voltage	48 V (32 V – 70 V)		
Max. charge/discharge current	65 A / 65 A		
<b>Input and Output (AC)</b>			
Nominal AC output power	3680 W	4600 W	5000 W <sup>(5)</sup>
Max. AC output apparent power	3680 VA	4600 VA	5000 VA <sup>(5)</sup>
Nominal AC output current	16.7 A <sup>(1)</sup>	20.9 A <sup>(3)</sup>	22.7 A <sup>(6)</sup>
Max. AC output current	16.7 A <sup>(1)</sup>	20.9 A <sup>(3)</sup>	22.7 A <sup>(6)</sup>
Max. AC input power	6680 W	7600 W	8000 W
Max. AC input current	30.4 A <sup>(2)</sup>	34.5 A <sup>(4)</sup>	36.4 A <sup>(7)</sup>
Max. inrush current (peak/duration)	10 A / 12 ms	10 A / 12 ms	10 A / 12 ms

Parameters	SH3K6-30	SH4K6-30	SH5K-30
Max. output fault current (peak/duration)	100 A / 3.2 ms	100 A / 3.2 ms	100 A / 3.2 ms
Max. output overcurrent protection	40 A	45 A	45 A
Nominal AC voltage	220 Vac / 230 Vac / 240 Vac		
AC voltage range	176 Vac – 276 Vac (this may vary with grid standards)		
Nominal grid frequency	50 Hz / 60 Hz		
Grid frequency range	45 Hz – 55 Hz / 55 Hz – 65 Hz (this may vary with grid standards)		
Total Harmonic Distortion (THD)	< 3 % (of nominal power)		
DC current injection	< 0.5 % (of nominal current)		
Power factor	> 0.99 at default value at nominal power (adj. 0.8 overexcited/leading – 0.8 underexcited/lagging)		
<b>Protection</b>			
Anti-islanding protection	Yes		
AC short circuit protection	Yes		
Leakage current protection	Yes		
DC fuse (battery)	Yes		
DC switch (solar)	Yes		Optional
Overvoltage category	III [Main], II [PV] [Battery]		
<b>System Data</b>			
Max. efficiency	97.70 %		
European efficiency	96.80 %	97.00 %	97.10 %
Max. charge/discharge efficiency	94.00 %		
Isolation method (solar)	Transformerless		
Isolation method (battery)	HF		
Ingress protection (IP) rating	IP65		
Pollution degree outside/inside the enclosure	3 / 2		
Operating ambient temperature range	-25°C to 60°C (> 45°C derating)		
Allowable relative humidity range	0 % – 100 %		
Cooling method	Natural convection		

Parameters	SH3K6-30	SH4K6-30	SH5K-30
Max. operating altitude	2000 m		
Display	Graphic LCD		
Communication	2 x RS485, Ethernet, Wi-Fi, CAN		
Power management	1 x Digital output		
Earth fault alarm	email, buzzer inside		
DC connection type	MC4		
AC connection type	Clamping yoke connector		
Certification	VDE-AR-N-4105, DIN VDE0126-1-1, G98, G99, CEI 0-21, IEC 62109-1, IEC62109-2, EN 62477-1, EN 61000-6-1/-3		AS4777, IEC 62109-1, IEC62109-2, IEC62477-1, IEC 62040-1, EN 61000-6-1/-3, NRS 097-2-1:2017, ABNT NBR 16149: 2013, ABNT NBR 16150: 2013
<b>Mechanical Data</b>			
Dimensions (W x H x D)	457 mm x 515 mm x 170 mm		
Mounting method	Wall-mounting bracket		
Weight	22 kg		
<b>Backup Data</b>			
Nominal voltage	220 Vac / 230 Vac / 240 Vac (± 2 %)		
Total harmonic factor output	2 % (full resistive load)		
Frequency range	50 Hz / 60 Hz (± 0.2 %)		
Switch time to emergency mode	< 20 ms		
Power factor	0.8 overexcited/leading to 0.8 underexcited/lagging		
Nominal AC output power	3000 W / 3000 VA		
Max. output power	3680 W / 3680 VA	4600 W / 4600 VA	5000 W / 5000 VA
Max. output power (battery)	3000 W / 3000 VA		
Peak output power, duration	6000 VA, 10 s		

- (1) Nominal/Max. AC output current of SH3K6-30 (G98): 16 A.
- (2) Max. AC input current from grid of SH3K6-30 (G99): 29 A.
- (3) Nominal/Max. AC output current of SH4K6-30 (VDE4105): 20 A.
- (4) Max. AC input current from grid of SH4K6-30 (VDE4105): 33 A.
- (5) Nominal AC output power to grid of SH5K-30 (AS4777): 4990 W.  
Max. AC output apparent power to grid of SH5K-30 (AS4777): 4990 VA.
- (6) Nominal/Max. AC output current of SH5K-30 (AS4777): 21.7 A.

(7) Max. AC input current from grid of SH5K-30 (AS4777): 34.8 A.

## 13.2 Meter

Parameters	Single-phase	Three-phase
Nominal voltage	240 Vac	230 Vac / 400 Vac
Input voltage range	180 Vac – 286 Vac	180 Vac – 276 Vac
Power consumption	< 2 W (10 VA)	< 2 W (10 VA)
Max. operating current	100 A	65 A
Grid frequency	50 Hz / 60 Hz	
Measurement accuracy	Class I	
Interface and communication	RS485	
Ingress protection rating	IP20	
Operating ambient temperature	-25°C to 75°C	-25°C to 70°C
Relative humidity	0 – 95 %	
Mounting method	35 mm DIN-rail	
Dimensions (W x H x D)	18 x 117 x 65 (mm)	85 x 72 x 72 (mm)
Weight	0.2 kg	0.4 kg

## 13.3 Quality Assurance

When product faults occur during the warranty period, SUNGROW will provide free service or replace the product with a new one.

### Evidence

During the warranty period, the customer shall provide the product purchase invoice and date. In addition, the trademark on the product shall be undamaged and legible. Otherwise, SUNGROW has the right to refuse to honor the quality guarantee.

### Conditions

- After replacement, unqualified products shall be processed by SUNGROW.
- The customer shall give SUNGROW a reasonable period to repair the faulty device.

### Exclusion of Liability

In the following circumstances, SUNGROW has the right to refuse to honor the quality guarantee:

- The free warranty period for the whole machine/components has expired.
- The device is damaged during transport.
- The device is incorrectly installed, refitted, or used.
- The device operates in harsh environment, as described in this manual.

- The fault or damage is caused by installation, repairs, modification, or disassembly performed by a service provider or personnel not from SUNGROW.
- The fault or damage is caused by the use of non-standard or non-SUNGROW components or software.
- The installation and use range are beyond stipulations of relevant international standards.
- The damage is caused by unexpected natural factors.

For faulty products in any of above cases, if the customer requests maintenance, paid maintenance service may be provided based on the judgment of SUNGROW.

## 13.4 Contact Information

Should you have any question about this product, please contact us.

We need the following information to provide you the best assistance:

- Model of the device
- Serial number of the device
- Fault code/name
- Brief description of the problem

### China (HQ)

Sungrow Power Supply Co., Ltd

Hefei

+86 551 65327834

[service@sungrowpower.com](mailto:service@sungrowpower.com)

### Australia

Sungrow Australia Group Pty. Ltd.

Sydney

+61 2 9922 1522

[service@sungrowpower.com.au](mailto:service@sungrowpower.com.au)

### Brazil

Sungrow Do Brasil

Sao Paulo

+55 11 2366 1957

[latam.service@sa.sungrowpower.com](mailto:latam.service@sa.sungrowpower.com)

### France

Sungrow France

Lyon

+33420102107

[service@sungrow-emea.com](mailto:service@sungrow-emea.com)

### Germany, Austria, Switzerland

Sungrow Deutschland GmbH

Munich

+49 0800 4327 9289

[service@sungrow-emea.com](mailto:service@sungrow-emea.com)

### Greece

Service Partner – Survey Digital

+30 2106044212

[service@sungrow-emea.com](mailto:service@sungrow-emea.com)

<p><b>India</b></p> <p>Sungrow (India) Private Limited Gurgaon +91 080 41201350 <a href="mailto:service@in.sungrowpower.com">service@in.sungrowpower.com</a></p>	<p><b>Italy</b></p> <p>Sungrow Italy Verona +39 0800 974739 (Residential) +39 045 4752117 (Others) <a href="mailto:service@sungrow-emea.com">service@sungrow-emea.com</a></p>
<p><b>Japan</b></p> <p>Sungrow Japan K.K. Tokyo + 81 3 6262 9917 <a href="mailto:service@jp.sungrowpower.com">service@jp.sungrowpower.com</a></p>	<p><b>Korea</b></p> <p>Sungrow Power Korea Limited Seoul +82 70 7719 1889 <a href="mailto:service@kr.sungrowpower.com">service@kr.sungrowpower.com</a></p>
<p><b>Malaysia</b></p> <p>Sungrow SEA Selangor Darul Ehsan +60 19 897 3360 <a href="mailto:service@my.sungrowpower.com">service@my.sungrowpower.com</a></p>	<p><b>Philippines</b></p> <p>Sungrow Power Supply Co., Ltd Mandaluyong City +63 9173022769 <a href="mailto:service@ph.sungrowpower.com">service@ph.sungrowpower.com</a></p>
<p><b>Thailand</b></p> <p>Sungrow Thailand Co., Ltd. Bangkok +66 891246053 <a href="mailto:service@th.sungrowpower.com">service@th.sungrowpower.com</a></p>	<p><b>Spain</b></p> <p>Sungrow Ib é rica S.A.U. Mutilva +34 948 05 22 04 <a href="mailto:service@sungrow-emea.com">service@sungrow-emea.com</a></p>
<p><b>Romania</b></p> <p>Service Partner - Elerex +40 241762250 <a href="mailto:service@sungrow-emea.com">service@sungrow-emea.com</a></p>	<p><b>Turkey</b></p> <p>Sungrow Deutschland GmbH Turkey Istanbul +90 216 663 61 80 <a href="mailto:service@sungrow-emea.com">service@sungrow-emea.com</a></p>
<p><b>UK</b></p> <p>Sungrow Power UK Ltd. Milton Keynes +44 (0) 01908 414127 <a href="mailto:service@sungrow-emea.com">service@sungrow-emea.com</a></p>	<p><b>U.S.A, Mexico</b></p> <p>Sungrow USA Corporation Phoenix +1 833 747 6937 <a href="mailto:techsupport@sungrow-na.com">techsupport@sungrow-na.com</a></p>

**Vietnam**

Sungrow Vietnam

Hanoi

+84 918 402 140

[service@vn.sungrowpower.com](mailto:service@vn.sungrowpower.com)**Belgium, Netherlands and  
Luxembourg (Benelus)**+31 08000227012 (only for  
Netherlands)[service@sungrow-emea.com](mailto:service@sungrow-emea.com)**Poland**

+48 221530484

-

[service@sungrow-emea.com](mailto:service@sungrow-emea.com)

Clean power for all

**SUNGROW**

**Sungrow Power Supply Co., Ltd.**

Add: No.1699 Xiyou Rd.,New & High Technology Industrial Development Zone, 230088,Hefei, P. R. China.

Web: [www.sungrowpower.com](http://www.sungrowpower.com)

Specifications are subject to changes without advance notice.